



Product catalogue



Factory Equipment



ABI Work Station



WKS Tool Cabinet



Series V Vertical Storage Cabinets



AGA Lever Arm



SBX Scrap Metal Box



Lift Equipment



WSW Workshop Trolleys



Workplace of the Future



KRS Kanban Shelf Cabinets



Factory equipment that fits



Apfel – solutions in metal

We have been active as a metalworking company in the development and production of professional factory equipment for the past 25 years.

Well-engineered products, proven and tested in daily work situations, are the result of our long-standing know-how and last but not least the continuous development in technology and the choice of sound materials and machining.

The principles of our company philosophy are framed in the optimization of production processes, the increase in storage capacity and efficiency as well as the reduction of access times.

In order to meet the highest level of customer satisfaction and quality all our products are produced, assembled and made ready for dispatch exclusively in our production plant in Dossenheim near Heidelberg, Baden-Württemberg.

On the following pages see for yourself a comprehensive range of practical high quality storage solutions that convince with expertise and diversity.



Content

Pages

WKS	Tool cabinets, technology and features	4 - 11
	Tool cabinets without tool retainers	12 - 13
	Tool cabinet sets for punching tools	14 - 15
	Punching equipment	16 - 17
SBX	Scrap metal box	18 - 19
WKS	Tool cabinet sets for bending tools	20 - 21
	Bending equipment	22 - 23
	Tool cabinet sets for milling and turning tools	24 - 27
	Milling and turning equipment	28 - 31
	Tool cabinet sets for deep-hole drills series B	32
	Tool cabinet sets for broaches series R	33
	Lift equipment	34 - 39
WKS	Tool cabinet sets with bulk trays series T	40 - 41
	Tool cabinet sets for single row box storage series L	42 - 43
	Tool cabinet sets for double row Kanban box storage series L plus	44 - 45
	Tool cabinet sets with perforated panels	46 - 47
	Perforated panels and equipment	48 - 49
WSL	Tool trolley and PC cart	50 - 51
ABI	Workstations Basic	52 - 53
	Workstations Set K	54
	Workstations Set PC	55
	Workstation Accessories	56 - 57
Series V	Vertical storage cabinets, technology and features.....	58 - 59
	Vertical storage cabinets Set unloaded and Set K	60 - 61
	Vertical storage cabinets Set O, Set E and Set K1	62 - 63
	Vertical storage cabinets Set S and Set KFZ	64 - 65
	Load carrier	66
RSW	wheeled shelf cabinets	67
WSW	workshop trolleys and TKW transport and commissioning carts	68
	Cleaning station, coolant cart and workshop trolley station	69
KRS	Kanban shelf cabinets	70 - 71
	Storage bins and Euro code cases	72 - 73
WGH	Wall bracket and AGA Lever arm	74 - 75
	Factory equipment in special colours	76 - 77
	Company-specific furnishing components and special solutions	78 - 79



WKS – The tool cabinet in a class of its own

The Apfel tool cabinets of the WKS series assure maximum organization at minimum space requirements. Thanks to vertical drawers, the tools are always ready-to-hand.

Direct access to the tooling from both sides provides increased safety as reaching over the tools is eliminated.

Perfectly tailored fittings with optimal space use ensure a protective storage of your tooling. Choose your fittings out of a broad product range of hundreds of tool retainers.

The robust steel construction of 3 mm sheet metal and travelling castors allow top payloads of up to 5,400 kg per cabinet. The castors guarantee the smooth and safe running of the vertical drawers.

Safe and functional technology made in Germany

First class components, best grade materials and high-quality processing guarantee maximum functionality and durability.

The production, mounting and dispatch of all WKS tool cabinets is exclusively implemented at our German production plants.

As a result of long-standing know-how in construction and production we offer you product solutions that bear maximum loads and charges. Manifold technical solutions ensure a time-saving, clean and safe handling of your tooling.

Integrated transport notches allow the easy relocation of your tool cabinet by lift truck or cart when empty.



Increased operational safety through direct both-sided access to the tools



Maximum payloads and safe guidance of the drawers thanks to travelling castors



Integrated transport notches allow the easy relocation by lift truck when empty



Useful storage space for small parts and measuring tools in each drawer



Boreholes in a 25 mm pattern allow the variable mounting of tool retainers



All drawers are individually lockable and are equipped with labeling fields



The suitable cabinet dimensions for your individual stock requirements

The WKS tool cabinets are available in different widths, heights and drawer versions.

We produce all cabinet formats in a standard depth of 1,050 mm as well as in an extended depth of 1,300 mm.

So you will find the perfect one which fits to your room conditions and the quantity of tools you want to store.

Whether the only 660 mm wide WKS 013, which also fits in the closest niche, the WKS 006, which offers space for hundreds of tools with a frontal width of one meter, or the WKS 005, which even stores biggest and heaviest tools – we have the right cabinet fitting to your needs.

The robust construction of powder-coated 3 mm sheet metal and the stable travelling wheels, which arrange a real smooth run and safe guidance of the drawers, allow highest lifting capacities up to 5,400 kg per cabinet resp. 1,800 kg per drawer.

Heavy-duty storage systems

WKS tool cabinets with 180 mm vertical drawers

All WKS tool cabinets are powder-coated in blue structure RAL 5010 (casing) and white structure RAL 9002 (drawers).

The entry models with 3 vertical drawers of 180 mm for well-arranged, safe and clean storage of your tools even at a minimum of space.

Our classics with five vertical drawers. Proven and tested, with sound technology, minimum space requirements and maximum stock capacity.

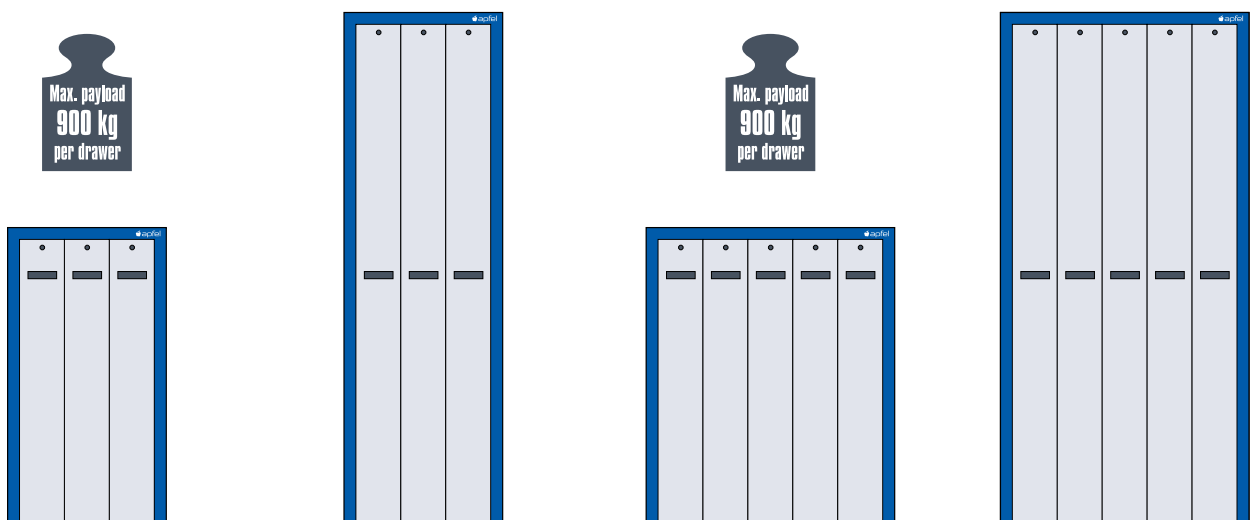

660 mm w x 1,240 mm h
max. payload 2.700 kg / cabinet

WKS 013 1,050 mm deep
WKS 033 1,300 mm deep

660 mm w x 2,140 mm h
max. payload 2.700 kg / cabinet

WKS 023 1,050 mm deep
WKS 063 1,300 mm deep

1,040 mm w x 1,240 mm h
max. payload 4,500 kg / cabinet

WKS 001 1,050 mm deep
WKS 003 1,300 mm deep

1,040 mm w x 2,140 mm h
max. payload 4,500 kg / cabinet

WKS 002 1,050 mm deep
WKS 006 1,300 mm deep

All your work utilities in just one tool cabinet

The different drawer versions and the large variety of configurations allow to create a clearly arranged storage place according to your requirements.

With our specially designed tool holders we offer perfect solutions for nearly all tool types used in the metal processing industry.

Furthermore, we provide additional components for an individual improvement of your tool cabinet.

Perforated panels, trays with storage bins, bulk trays and even holders for your working documents, you will find almost everything you need in our extensive range of accessories.

Store all necessary materials you need at your workplace in only one cabinet to save time and ways.

Storage of milling and turning tools



WKS tool cabinets with 300 mm vertical drawers

All WKS tool cabinets are powder-coated in blue structure RAL 5010 (casing) and white structure RAL 9002 (drawers).

The cabinets for extreme loads. Three vertical drawers with special ballbearing plastic rollers allow maximum payloads of up to 5,400 kg per cabinet.

Two different drawer types (1 x 300 mm, 3 x 180 mm) in only one cabinet allow the storage of diverse tools in a well-arranged, clean and safe way.

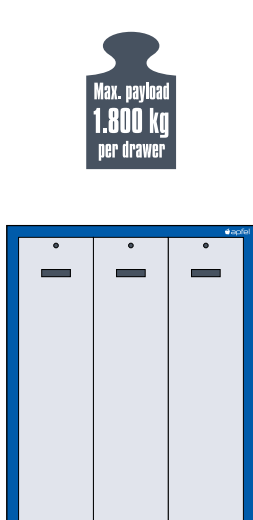

1,040 mm w x 1,240 mm h
max. payload 5,400 kg / cabinet

WKS 008 1,050 mm deep
WKS 009 1,300 mm deep

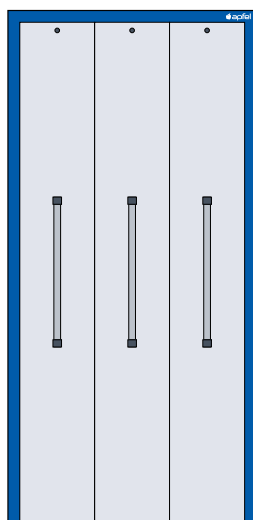

1,040 mm w x 2,140 mm h
max. payload 5,400 kg / cabinet

WKS 004 1,050 mm deep
WKS 005 1,300 mm deep

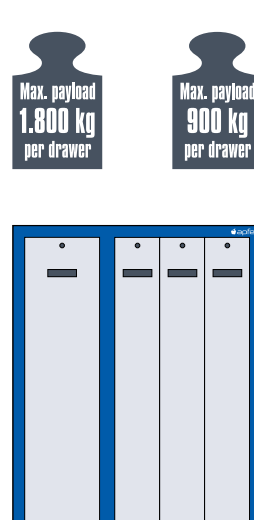

1,040 mm w x 1,240 mm h
max. payload 4,500 kg / cabinet

WKS 014 1,050 mm deep
WKS 034 1,300 mm deep

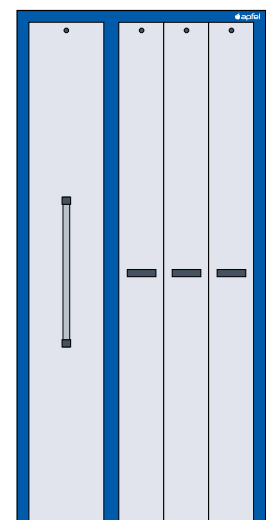

1,040 mm w x 2,140 mm h
max. payload 4,500 kg / cabinet

WKS 024 1,050 mm deep
WKS 064 1,300 mm deep

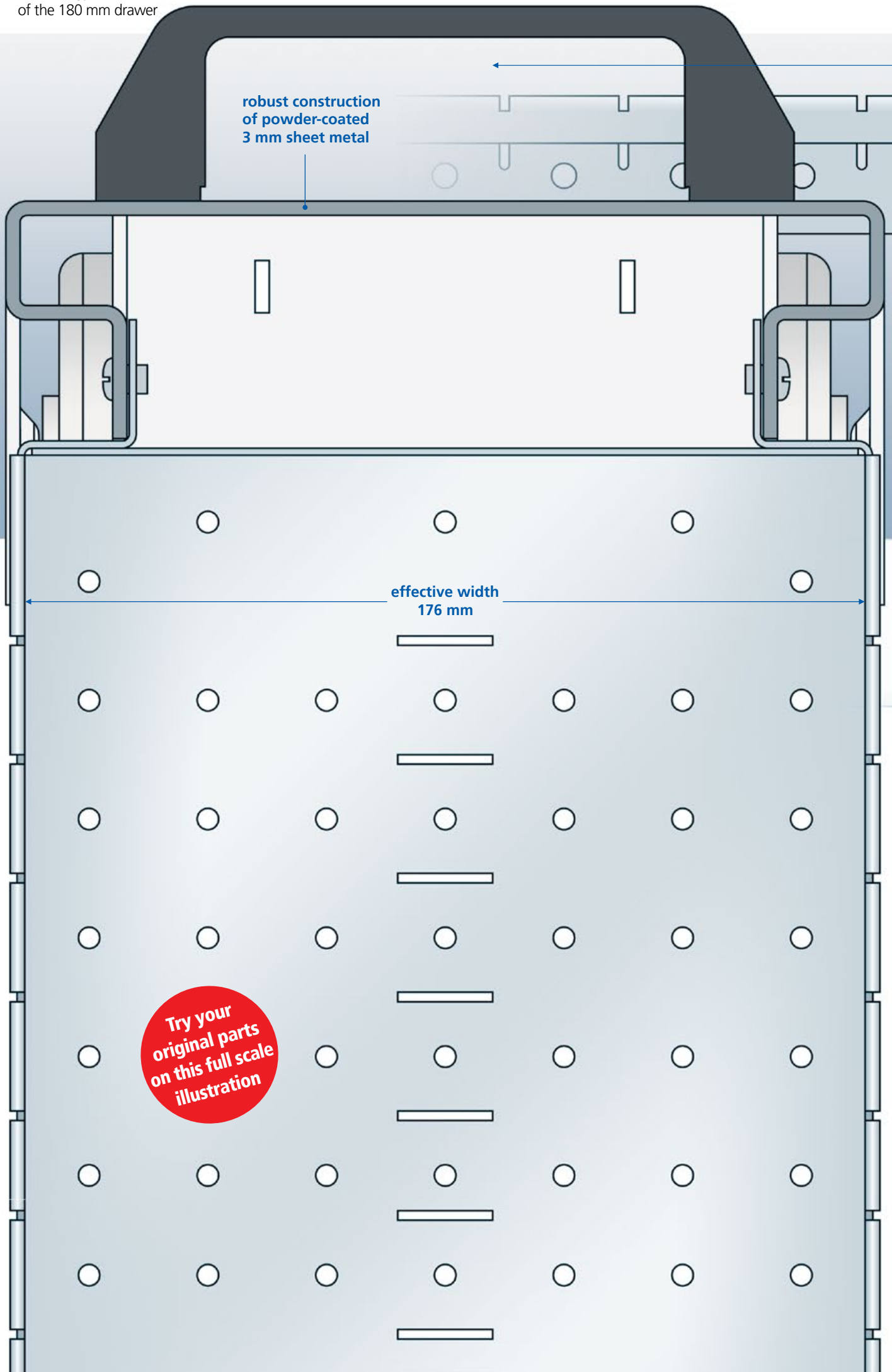

robust construction
of powder-coated
3 mm sheet metal

effective width
176 mm

Try your
original parts
on this full scale
illustration

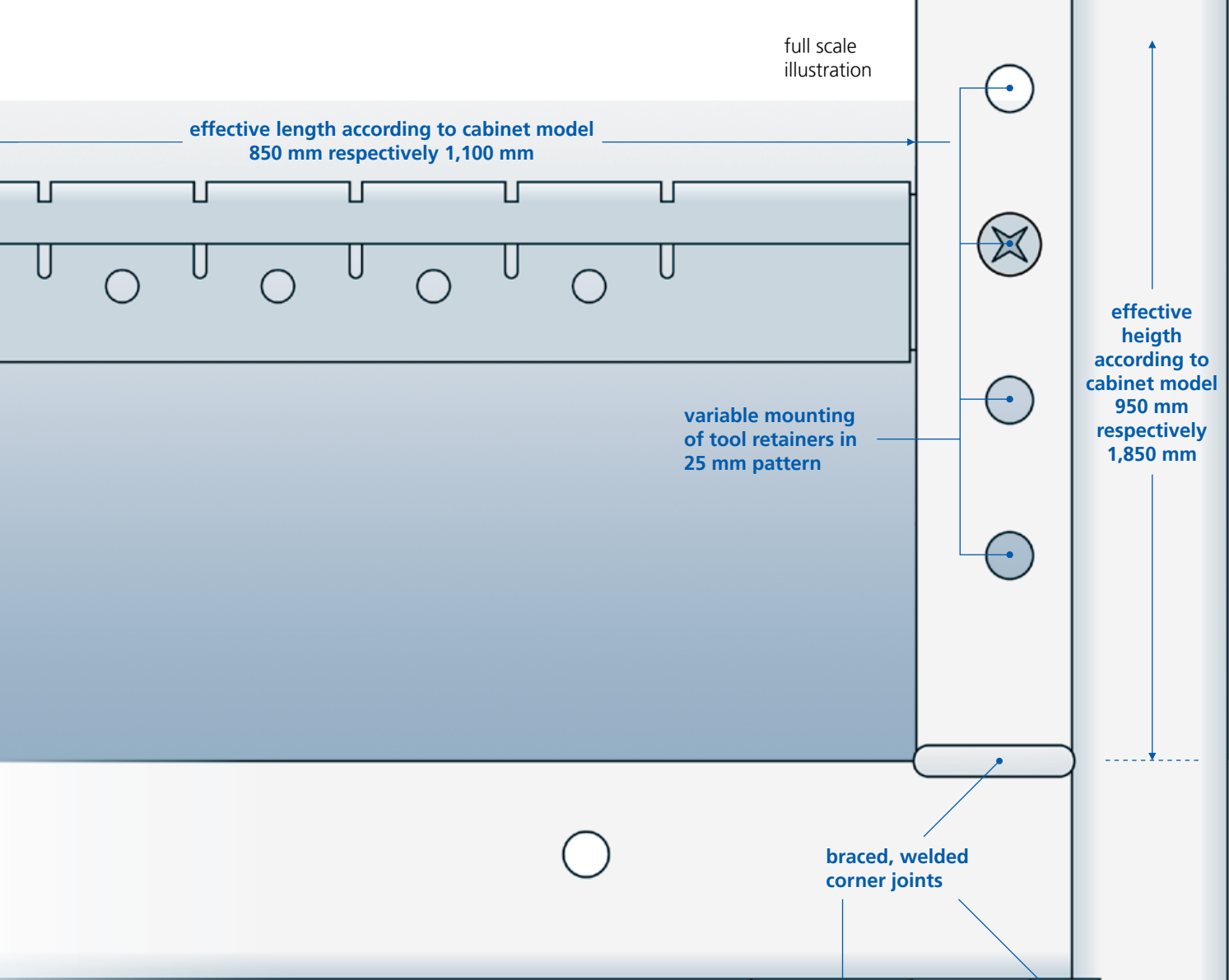

braced, welded corner joints

The All-rounder for many storage purposes!

The 180 mm drawer offers a broad variety of storage trays, perforated panels and tool retainers and therefore plenty of opportunities for the ideal and individual fitting of your tool cabinet.

Our long standing know-how in construction and production guarantee a product with well-engineered technology, high handling comfort and sound functioning.

Maximum capacity at minimum space presents the main construction principle of our vertical storage cabinets.

With this system you store large amounts of tools, hundreds of small parts or all necessary devices for your workstation at little floor space and minimum front width.



max. payload
900 kg

The heavyweight for extreme loads

With our "Panzer" drawer you store even heavy tools in a safe and gentle way. An effective width of almost 300 mm offers adequate storage volume for large tooling.

High grade components, sound processing and extremely robust, ball-bearing plastic rollers guarantee maximum stability and long-life, proper functioning.

Various tool retainers with different fittings and flexible mounting allow the individual arrangement of your storage cabinet according to your operational requirements.

The drawer that withstands even highest loads!

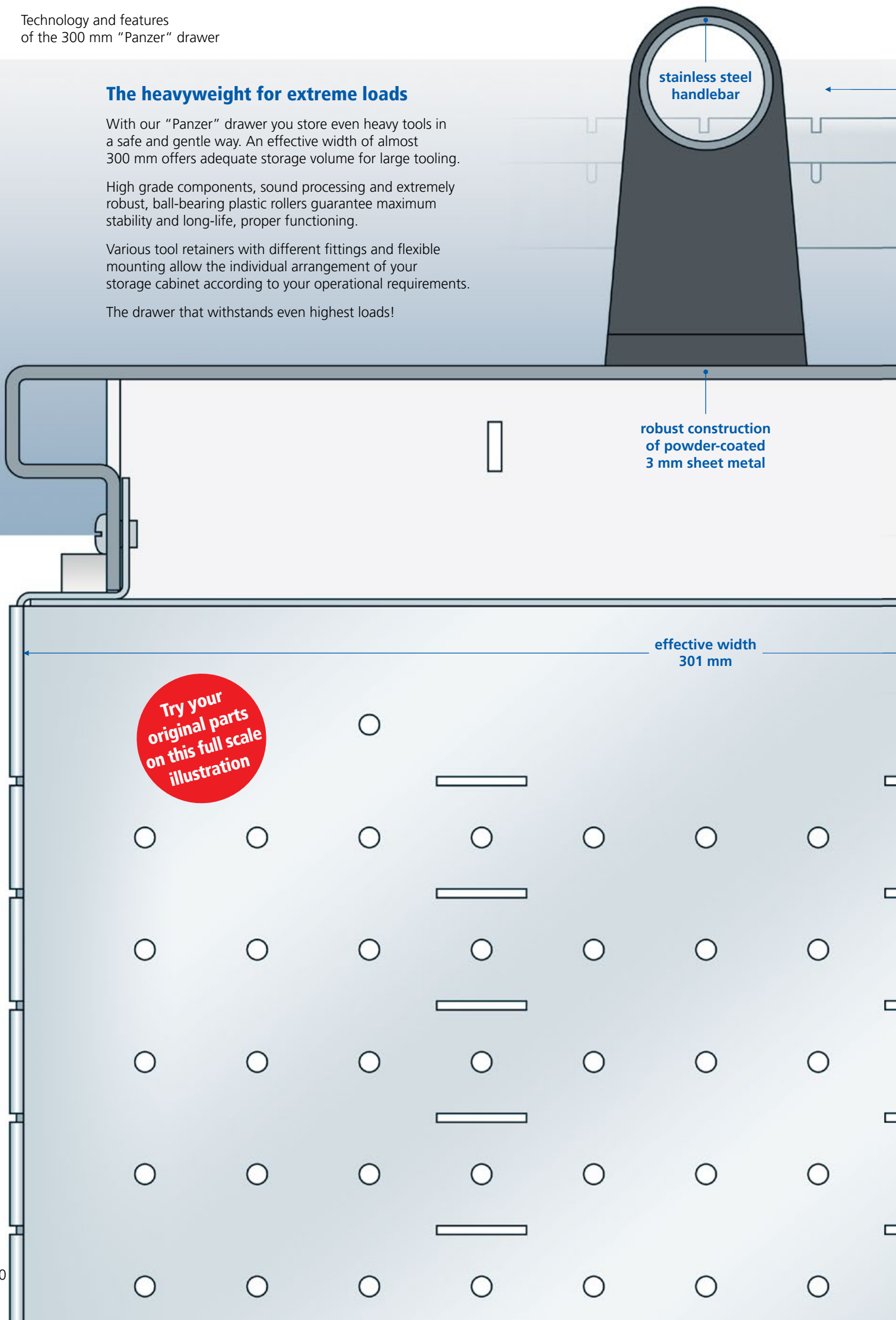

stainless steel
handlebar

robust construction
of powder-coated
3 mm sheet metal

effective width
301 mm

Try your
original parts
on this full scale
illustration

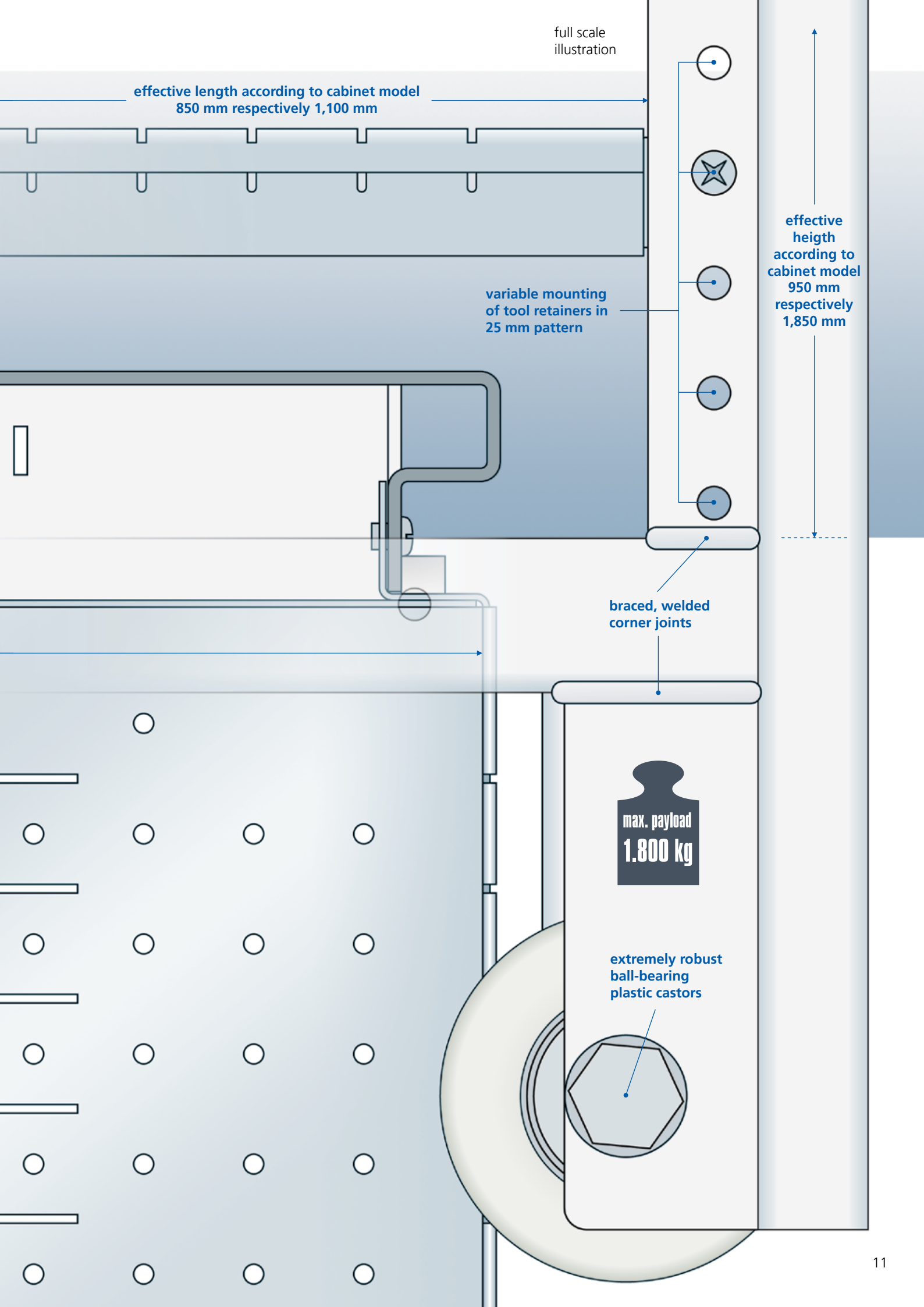

full scale illustration

effective length according to cabinet model
850 mm respectively 1,100 mm

variable mounting
of tool retainers in
25 mm pattern

effective height
according to
cabinet model
950 mm
respectively
1,850 mm

braced, welded
corner joints

max. payload
1.800 kg

extremely robust
ball-bearing
plastic castors



WKS 013 The competitive starter model with high storage capacity at minimum space.

With 3 vertical drawers à 180 mm
660 w x 1,240 h x 1,050 d
Order No. 2330532 1.350,00

WKS 033 With 250 mm extended depth
660 w x 1,240 h x 1,300 d
Order No. 2330893 1.490,00



WKS 001 The classic with 5 vertical drawers with highest storage capacity at minimum space requirements.

With 5 vertical drawers à 180 mm
1,040 w x 1,240 h x 1,050 d
Order No. 2330050 1.630,00

WKS 003 With 250 mm extended depth
1,040 w x 1,240 h x 1,300 d
Order No. 2330163 1.780,00



WKS 023 The tool cabinet for high storage capacity at extremely limited space.

With 3 vertical drawers à 180 mm
660 w x 2,140 h x 1,050 d
Order No. 2330354 1.950,00

WKS 063 With 250 mm extended depth
660 w x 2,140 h x 1,300 d
Order No. 2330892 2.290,00



WKS 002 The classic in portrait format with the highest storage capacity and optimal access to your stock.

With 5 vertical drawers à 180 mm
1,040 w x 2,140 h x 1,050 d
Order No. 2330086 2.280,00

WKS 006 With 250 mm extended depth
1,040 w x 2,140 h x 1,300 d
Order No. 2330392 2.580,00



WKS 008
"Panzer"

The low tool cabinet for the storage of heavy loads and large parts.
With 3 vertical drawers à 300 mm
1,040 w x 1,240 h x 1,050 d
Order No. 2330849 1.780,00

WKS 009
"Panzer"

With 250 mm extended depth
1,040 w x 1,240 h x 1,300 d
Order No. 2330347 1.980,00



WKS 014

The compact cabinet with diverse drawer sizes.
With 3 vertical drawers à 180 mm and 1 vertical drawer à 300 mm
1,040 w x 1,240 h x 1,050 d
Order No. 2330894 1.780,00

WKS 034

With 250 mm extended depth
1,040 w x 1,240 h x 1,300 d
Order No. 2330895 1.880,00



WKS 004
"Panzer"

The tool cabinet for the safe storage of heavy weights or large parts.
With 3 vertical drawers à 300 mm
1,040 w x 2,140 h x 1,050 d
Order No. 2330400 2.780,00

WKS 005
"Panzer"

With 250 mm extended depth
1,040 w x 2,140 h x 1,300 d
Order No. 2330500 3.150,00



WKS 024

The combined tool cabinet with diverse drawer sizes.
With 3 vertical drawers à 180 mm and 1 vertical drawer à 300 mm
1,040 w x 2,140 h x 1,050 d
Order No. 2330846 2.460,00

WKS 064

With 250 mm extended depth
1,040 w x 2,140 h x 1,300 d
Order No. 2330847 2.780,00

Tool replacement within seconds!



The WKS tool cabinets for punching tools perfectly match the production with your punching machine such as Trumpf. Specially designed tool retainers store all types of punching tools accurately in its place. Reduce costly setup times due to an easy and fast access and enhance the durability of expensive tooling.

Also available for
Wilson Tool,
Salvagnini,
Amada etc.

OUR TOOL CABINETS ARE EXCLUSIVELY
MADE IN GERMANY
MANUFACTURED IN GERMANY



WKS 001 Set S plus

WKS 002 Set S

WKH 210



WKH 211



WKH 212



WKH 213



WKS 013 Set S

The competitive starter model with only 0,7 square metres floor space.

Incl. 3 tool carriers WKH 210,
4 tool carriers WKH 211,
3 tool carriers WKH 212,
3 tool carriers WKH 213,
1 tool carrier WKH 214,
1 tool carrier WKH 215,
2 tool trays WEB 360,
1 tool tray WEB 367

660 b x 1,240 h x 1,050 d

Order No. 2331085 2.450,00



WKS 001 Set S

The proven and tested standard model with well-arranged layout.

Incl. 4 tool carriers WKH 210,
4 tool carriers WKH 211,
4 tool carriers WKH 212,
4 tool carriers WKH 213,
2 tool carriers WKH 214,
2 tool carriers WKH 215,
3 tool trays WEB 360,
2 tool trays WEB 367

1,040 w x 1,240 h x 1,050 d

Order No. 2331086 3.170,00

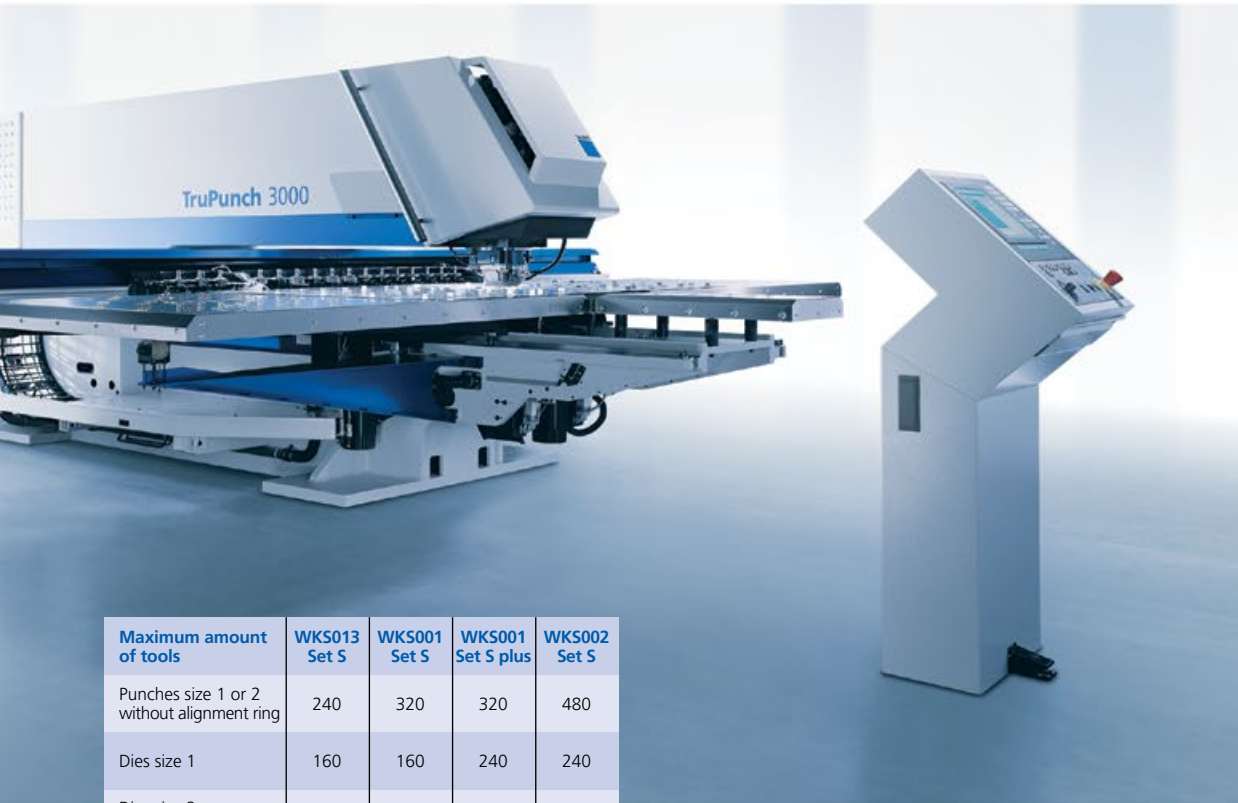

Maximum amount of tools	WKS013 Set S	WKS001 Set S	WKS001 Set S plus	WKS002 Set S
Punches size 1 or 2 without alignment ring	240	320	320	480
Dies size 1	160	160	240	240
Dies size 2 or reception rings	30	40	50	50
Strippers	120	160	200	200
Sets of forming or special tooling	4	8	12	16
Setup cartridges	5	10	10	20



WKS 001 Set S plus

Best Seller

The compact model with fittings for intensive set-up processes.

Incl. 4 tool carriers WKH 210, 6 tool carriers WKH 211, 5 tool carriers WKH 212, 5 tool carriers WKH 213, 3 tool carriers WKH 214, 2 tool carriers WKH 215, 3 tool trays WEB 360, 2 tool trays WEB 367

1,040 w x 1,240 h x 1,050 d

Order No. 2331087 3.590,00

WKS 002 Set S

The ultimate storage potential in portrait format. Abundant storage capacity for frequent tool changing processes.

Incl. 6 tool carriers WKH 210, 6 tool carriers WKH 211, 5 tool carriers WKH 212, 5 tool carriers WKH 213, 4 tool carriers WKH 214, 4 tool carriers WKH 215

1,040 b x 2,140 h x 1,050 d

Order No. 2331088 4.440,00

Punching tool retainers and inserts for WKS tool cabinets

Precisely worked – for accurate bearing and optimal use of space. Mountable in 25 mm pattern.



WKH 210

Tool carrier for punches size 1 and 2, with or without alignment ring, for 80 pieces max.
fitting to WKS
001, 002, 013, 014, 023, 024
Order No. 2334000 88,00



WKH 211

Tool carrier for dies size 1, for 40 pieces max.
fitting to WKS
001, 002, 013, 014, 023, 024
Order No. 2334001 88,00



WKH 212

Tool carrier for dies size 2 or reception rings or strippers, for 10 pieces or 10 sets max.
fitting to WKS
001, 002, 013, 014, 023, 024
Order No. 2334002 88,00

Also available for
Wilson Tool,
Salvagnini,
Amada etc.



WKH 213

Tool carrier for strippers, for 40 pieces max.
fitting to WKS
001, 002, 013, 014, 023, 024
Order No. 2334003 88,00



WKH 214

Tool carrier for special and forming tools, for 4 full sets max.
fitting to WKS
001, 002, 013, 014, 023, 024
Order No. 2334004 109,00



WKH 215

Tool carrier for setup cartridges equipped or unequipped, for 5 pieces max.
fitting to WKS
001, 002, 013, 014, 023, 024
Order No. 2334005 88,00



WKH 216

Tool carrier for special tools, for 12 pieces max.
fitting to WKS
001, 002, 013, 014, 023, 024
Order No. 2334008 88,00



WEB 360

Tool tray inlays for punch needles, adjusting rings, inserts, including 4 dividers
fitting to WKS
001, 002, 013, 014
Order No. 2334006 29,00



WEB 367

Tool tray inlays for cutter bars and cuttings stamps 5 x 76,2 or 5 x 56
fitting to WKS
001, 002, 013, 014
Order No. 2334007 29,00

Transport your setup cartridges with the WSW 581

With a robust drawer, mountable from both sides, stainless steel handle bar, fixed castors and guided rollers and a total payload of 400 kg, the Apfel trolley WSW adds up to an essential mobile aid in your production.

The specially sloped tool retainers with integrated oil binding felt inlay transport up to 45 setup cartridges easy and safe to and from your punching machine.

WSW 581 punching

Transport cart for setup cartridges incl 1 even shelf and 9 tool carriers WKT 811

Dimensions without handlebar:
582 w x 922 h x 922 d

Order No. 2331244 780,00

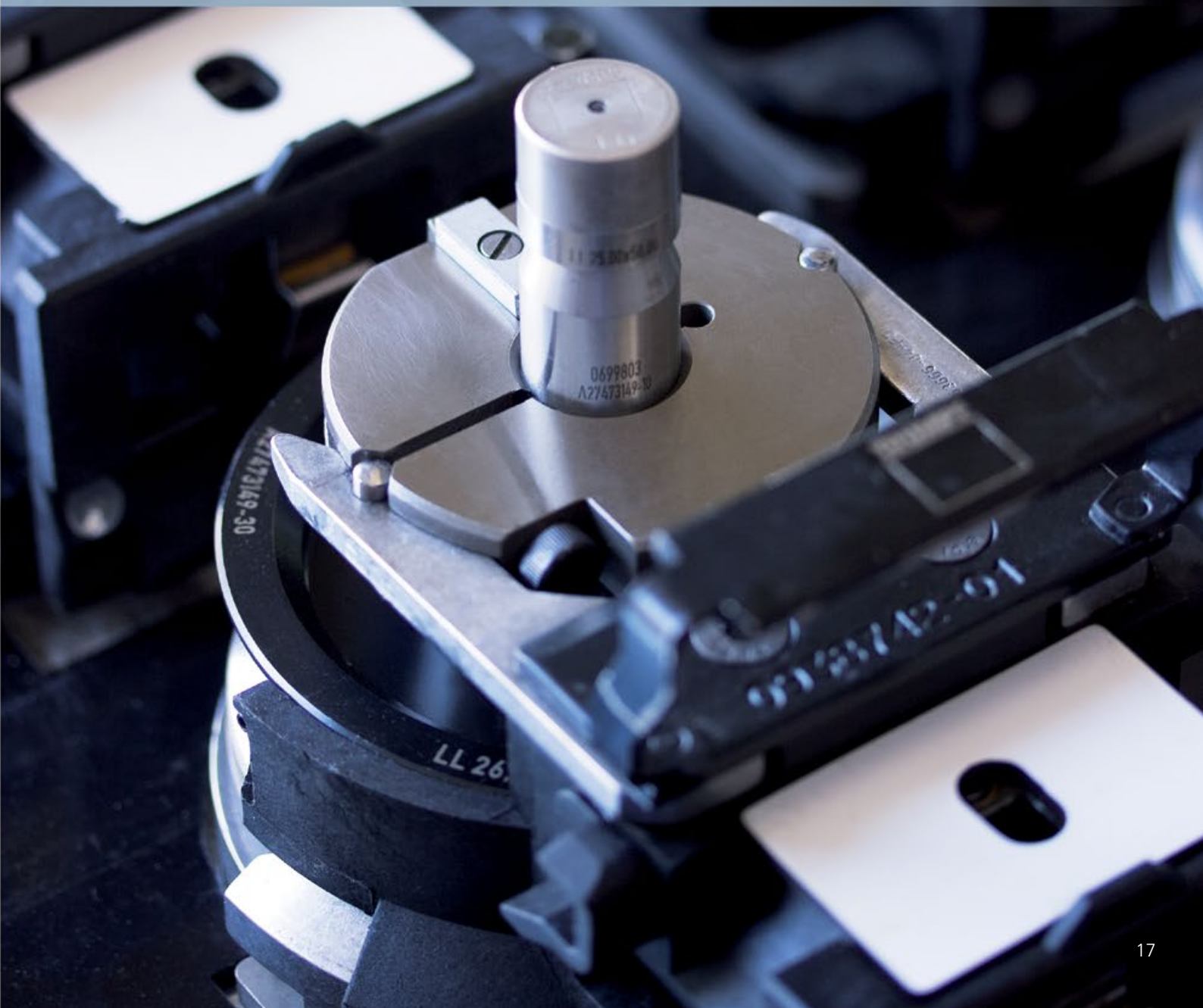

The Apfel scrap box – space saving storage and secure disposal of your sheet metal scrap

The scrap metal box, which has been especially constructed for metalworking companies, presents the safe and functional method for contemporary handling of sheet metal scrap.

The sound steel construction comes with a drop bottom that opens up easily and safe by hydraulic dampers to allow the easy discharge of metal scrap by lift truck without perilous shifting.

After its discharge the scrap box is put back down to the ground. Integrated rollers entirely close the bottom hinges. Finally the opening locks are to be reattached – that's it.



The hinged drop bottom allows the easy discharge of sheet metal scrap into a container by lift truck.



Apfel scrap metal boxes are equipped with hydraulic dampers that allow a slow and controlled opening of the bottom hinges.

SBX 1020

Scrap metal box for 1.000 x 2.000 mm small size sheet metal
Outer dimensions ca. 1,570 w x 2,400 l x 600 h
Maximum payload 2,000 kg
Blue RAL 5010 powder-coated

Order No. 2330460 6.880,00

SBX 1225

Scrap metal box for 1.250 x 2.500 mm medium size sheet metal
Outer dimensions ca. 1,820 w x 2,900 l x 600 h
Maximum payload 2,000 kg
Blue RAL 5010 powder-coated

Order No. 2330054 7.580,00

SBX 1530

Scrap metal box for 1.500 x 3.000 mm large size sheet metal
Outer dimensions ca. 2,070 w x 3,400 l x 600 h
Maximum payload 2,000 kg
Blue RAL 5010 powder-coated

Order No. 2330459 7.980,00

Professional disposal of sheet metal scrap

The Apfel SBX scrap metal box is a solid steel construction that comes with a drop bottom, which allows an easy discharge by lift truck or crane.

During the transport the box is secured with additional safety locks. On the spot, the locker bolts can be removed with just a few twists.

In order to discharge the scrap metal box, the trigger bracket is particularly important. When placing the scrap metal box on the edge of the container, it automatically opens the bottom flaps. Hydraulic cylinders with an integrated compensating diaphragm ensure a smooth stopping of the bottom flaps to enable a slow and controlled emptying.

After the disposal of the sheet metal scraps the opened box gets set back on the ground, while the castors on the bottom flaps close it completely.

Once this has been done, the scrap metal box is automatically locked and ready to use again.



Practical details to ensure highest work safety and trouble-free handling



Additional safety lock

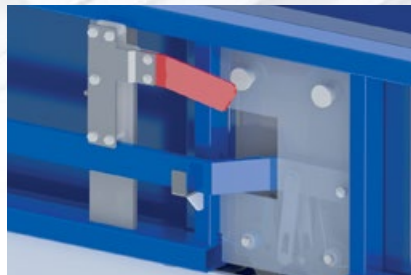

Self-closing unlocking lever



Lifting gear

The safe storage of bending tools

The WKS tool cabinet series for bending tools support a maximum of safety for the work surroundings of your press brake. Robust and perfectly fitted tool retainers store up large amounts of tools with direct access to the machine. Reduce your setup times and increase the durability of your tooling.



WKS 002 Set A

WKS 001 Set A



The tools can be stored standing, turning upside down is not necessary.



WKS 013 Set A

The roomster in storing
Store appr. 16 running metres of bending tools in a tool cabinet with a front width of only 660 mm.
Incl. 9 tool carriers WKH 102 and 3 tool tray inlays WEB 360 with 4 dividers TRB 360 each
660 w x 1,240 h x 1,050 d
Order No. 2330584 1.695,00



WKS 001 Set A

The classic with 5 drawers
Reduce your set-up times through the optimal access to up to 26 metres of bending tools.
Incl. 15 tool carriers WKH 102 and 5 tool tray inlays WEB 360 with 4 dividers TRB 360 each
1,040 w x 1,240 h x 1,050 d
Order No. 2330087 2.240,00



WSW 583 bending plus

Approx.
44 rm of tools
plus lots of
small parts



Approx.
33 rm of
bending
tools



WKS 003 Set A

Best Seller

Increased capacity through extended depth
Store up to 33 running metres of tools due to deeper drawers.
Incl. 15 tool carriers WKH 103 and 5 tool trays WEB 366 with 5 partition plates TRB 366 each
1,040 w x 1,240 h x 1,300 d
Order No. 2330164 2.398,00

WKS 006 Set A

The tool cabinet in portrait format
Aprx. 44 running metres of bending tools and lots of small parts at once.
Incl. 20 tool carriers WKH 103, 10 tool carriers WKH 504, 60 storage bins KLF 211 (No. 11) and 1 perforated panel WKH 830
1,040 w x 2,140 h x 1,300 d
Order No. 2330391 4.189,00



Compatible and safe technology: Apfel WSW workshop trolleys for bending tools

Inwardly sloped shelves with a middle partition allow a safe transport of bending tools. With the integrated drawer the WSW models 582 and 583 keep your measuring devices dust free and perfectly complement to your bending machine.

With a robust drawer, mountable from both sides, stainless steel handle bar, fixed castors and guided rollers and a total payload of 400 kg, the Apfel trolley WSW adds up to an essential mobile aid in your production.



Starter-kit bending

including:

Magnet Holder set

Carrier for setting blocks

Hang-up tray

Order No. 2332102 255,00

Bending tool retainers for WKS tool cabinets

Optimal access and safe storage. Mountable in 25 mm pattern.



WKH 102

for appr. 1.7 running metres
of bending tools
fitting to WKS
001, 002, 013, 014, 023, 024
Order No. 2330135 49,50



WKH 103

for appr. 2.2 running metres
of bending tools
fitting to WKS
003, 006, 033, 034, 063, 064
Order No. 2330165 58,00



WSW 582 bending

Incl. 2 inward sloped shelves
with middle partition
and 1 rubber mat

Dimensions without handlebar:
582 w x 922 h x 922 d

Order No. 2331241 480,00



WSW 583 bending plus

Incl. 2 inward sloped shelves
with middle partition
and 3 tool carriers

Dimensions without handlebar:
582 w x 922 h x 922 d

Order No. 2331153 680,00

Magnet holder set

for Trumpf measuring tools,
consisting of 2 magnet holders
44 w x 68 h x 40,2 d

Order No. 2332028 98,00



Practical equipment for your TrumaBend press brake

Usefull extensions for your daily work.

Carrier for setting blocks

made of stainless steel, for the attachment to Trumpf press brake air cylinders

Dimensions: 167,5 l x 68,0 w x 65,1 h

Order No. 2331169 2 pcs. 78,00

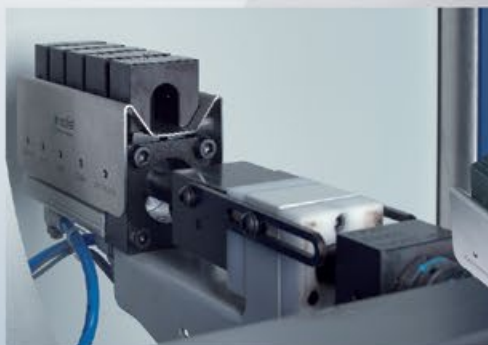

Hang-up tray

for measuring devices, compatible with the machine table or guide rail

Dimensions: 450 l x 245 w x 65 h

Order No. 2331182 98,00



Reduce your setup times with Apfel

Apfel tool cabinets for milling and turning tools store up all common types of CNC tooling in a clean, safe and gentle way. A unique tool retainer system with small reduction hooks allows optimal arrangement and fast access. The system saves valuable time and needless ways. Your tools are kept free from dust and damage.



Available
for all
necessary
cutting
tools

OUR TOOL CABINETS ARE EXCLUSIVELY
MADE IN GERMANY
MANUFACTURED IN GERMANY



WKS 002 Set Z

WKS 001 Set Z



plus
250 mm

WKS 013 Set Z

Store up to 144 cutting tools in a cabinet with a front width of only 660 mm (e.g. SK 40).

Incl. 9 tool carriers WKH 403

660 w x 1,240 h x 1,050 d

Order No. 2330721 1.695,00

WKS 033 Set Z

Up to 180 tools thanks to 250 mm extended depth (e.g. SK 40).

Incl. 9 tool carriers WKH 406

660 w x 1,240 h x 1,300 d

Order No. 2331419 1.940,00



plus
250 mm

Store up
to 240
cutting tools
(e.g. SK 40)

WKS 001 Set Z

Best
Seller

Reduce your set-up times through the optimal access to max. 240 cutting tools (e.g. SK 40).

Incl. 15 tool carriers WKH 403

1,040 w x 1,240 h x 1,050 d

Order No. 2330099 2.240,00

WKS 003 Set Z

Up to 300 tools thanks to 250 mm extended depth (e.g. SK 40).

Incl. 15 tool carriers WKH 406

1,040 w x 1,240 h x 1,300 d

Order No. 2330860 2.590,00



WSW 584
milling and turning



WKS 008
Set Z
"Panzer"

Store up to 90 heavy weight cutting tools in 3 drawers with 1.800 kg payload each (e.g. SK 40).
Incl. 9 tool carriers WKH 918
1,040 w x 1,240 h x 1,050 d
Order No. 2331890 2.280,00

WKS 009
Set Z
"Panzer"

Up to 126 tools thanks to 250 mm extended depth (e.g. SK 40)
Incl. 9 tool carriers WKH 919
1,040 w x 1,240 h x 1,300 d
Order No. 2331889 2.580,00



WKS 023
Set Z

Only 660 mm cabinet front width allow a storage of 288 cutting tools (e.g. SK 40).
Incl. 18 tool carriers WKH 403
660 w x 2,140 h x 1,050 d
Order No. 2331017 2.650,00

WKS 063
Set Z

Up to 360 tools thanks to 250 mm extended depth (e.g. SK 40).
Incl. 18 tool carriers WKH 406
660 w x 2,140 h x 1,300 d
Order No. 2331420 2.950,00





**WKS 004
Set W
"Panzer"**

With a payload of 1,800 kg per drawer you store heavy special tooling robust and safe.

Incl. 18 tool carriers WKH 905
1,040 w x 2,140 h x 1,050 d

Order No. 2330480 3.820,00

**WKS 005
Set W
"Panzer"**

Appr. 25% more storage space thanks to 250 mm extended depth.

Incl. 18 tool carriers WKH 906
1,040 w x 2,140 h x 1,300 d

Order No. 2330580 4.280,00



**WKS 024
Set Z**

Takes up 348 tools max. in three small drawers and heavy loads in a separate one with 1,800 kg payload.

Incl. 18 WKH 403 and 6 WKH 918
1,040 w x 2,140 h x 1,050 d

Order No. 2331428 3.480,00

**WKS 064
Set Z**

444 cutting tools thanks to 250 mm extended depth (z.B. SK 40).

Incl. 18 WKH 406 and 6 WKH 919
1,040 w x 2,140 h x 1,300 d

Order No. 2331429 4.240,00



WKH 918



WKH 919



WKH 905



WKH 906

Milling and turning tool retainers for WKS tool cabinets

Fully equipped with tool holders and reduction hooks. Mountable in 25 mm pattern.



Tool carrier		WKH 403	WKH 406	WKH 404	WKH 405	WKH 918	WKH 919
Max. capacity		16 tools	20 tools	7 tools	9 tools	10 tools	14 tools
fitting to tool cabinet WKS		001, 002, 013, 014, 023, 024	003, 006, 033, 034, 063, 064	001, 002, 013, 014, 023, 024	003, 006, 033, 034, 063, 064	004, 008, 014, 024	005, 009, 034, 064
	HSK 40 	2330709	2330896	2330940	2330952	2331373	2331411
	HSK 50 	2331022	2331213	2331365	2331227	2331376	2331412
	HSK 63 	2330137	2330897	2330783	2330953	2331374	2331413
	HSK 63-F 	2330933	2331370	2330941	2330954	2331375	2331414
	HSK 80 	-	-	2330948	2330966	2331377	2331396
	HSK 100 	-	-	2330255	2330914	2331378	2331290
	SK 30 	2330134	2330898	2330884	2330955	2331371	2331415
	SK 40 	2330095	2330899	2330740	2330925	2331372	2331416
	SK 50 	-	-	2330714	2330913	2331298	2331291
	Capto C3 	2331222	2331369	2331364	2331367	2331385	2331403
	Capto C4 	2330935	2330968	2330942	2330958	2331386	2331404
	Capto C5 	2330767	2330910	2330943	2330959	2331387	2331405
	Capto C6 	2330765	2330911	2330944	2330960	2331388	2331406
	Capto C8 	-	-	2330769	2330915	2331389	2331397
	VDI 20 	2330707	2330907	2330762	2330956	2331379	2331399
	VDI 25 	2330708	2331211	2330763	2331226	2331380	2331400
	VDI 30 	2330170	2330908	2330851	2330926	2331381	2331401
	VDI 40 	2330172	2330909	2330722	2330927	2331382	2331331
	VDI 50 	2330934	2331188	2330277	2330957	2331383	2331402
	VDI 60 	-	-	2330717	2330912	2331384	2331395
	ABS 50 	2331362	2331368	2331363	2331366	2331392	2331408
	ABS 63 	2330938	2330970	2330946	2330962	2331391	2331409
	ABS 80 	2330939	2330971	2330947	2330963	2331393	2331410
	UTS 63 	2330937	2330969	2330945	2330961	2331390	2331407
	UTS 80 	-	-	2330949	2330967	2331394	2331398
	173 E 	2330716	2331425	2331423	2331424	2331426	2331427
Price		54,00	69,00	54,00	69,00	79,00	94,00

Protective, clean and well-arranged storage of milling & turning tools

The perfectly tailored tool retainers by Apfel allow a safe storage of tongs, turning and milling tools.

The screwed tool carriers are equipped with coloured reduction hooks for each tool type such as SK, HSK, VDI, ABS or Capto.

The construction allows the individual setup of your tool cabinet, according to your requirements.

Our flexible construction guarantees an easy and fast exchange of hooks and tool retainers.

More than 20 combinations of hooks in only 2 diameters of tool retainers allow the simultaneous storage of all known cutting tool types in one tool cabinet system.



Available for all common cutting tools





Universal tool trays for WKS tool cabinets (180 mm drawers)

For the storage of most diverse stock – for optional assembly with multi-purpose equipment.



WKH 502

Tool tray 30 mm high,
for assembly with partition
plates, collet inlay sets, storage
boxes or drilling inlay blocks
fitting to WKS
001, 002, 013, 014, 023, 024
Order No. 2330348 49,50



WKH 504

Tool tray 30 mm high,
for assembly with partition
plates, collet inlay sets, storage
boxes or drilling inlay blocks
fitting to WKS
003, 006, 033, 034, 063, 064
Order No. 2330452 58,00



WKH 506

Tool tray 49 mm high,
for assembly with partition
plates, collet inlay sets, storage
boxes or drilling inlay blocks
fitting to WKS
001, 002, 013, 014, 023, 024
Order No. 2330477 49,50



Inlay plates for collets

Tool plates for tongs with POM cover plates for a gentle storage.
Format 173 w x 283 l, fitting to WKH 502, 503, 504, 505.

ELS650 for 45 collets ER 11

Order No. 2330754 19,80

ELS651 for 45 collets ER 16

Order No. 2330715 19,80

ELS652 for 45 collets ER 20

Order No. 2330706 19,80

ELS653 for 45 collets ER 25

Order No. 2330718 19,80

ELS654 for 28 collets ER 32

Order No. 2330719 19,80

ELS655 for 15 collets ER 40

Order No. 2330720 19,80

ELS656 for 15 collets ER 50

Order No. 2330756 19,80

Universal tool trays for WKS tool cabinets (300 mm drawers "Panzer")

For the storage of extreme weights or large stock.



WKH 903

Tool tray for heavy loads
for optional assembly with
dividers
fitting to WKS
004, 008, 014, 024
Order No. 2330463 65,00



WKH 904

Tool tray for heavy loads
for optional assembly with
dividers
fitting to WKS
005, 009, 034, 064
Order No. 2330464 74,00



WKH 905

Tool tray for heavy loads
open to one side, easy
handling without lifting
fitting to WKS
004, 008, 014, 024
Order No. 2330585 65,00



WKH 505

Tool tray 49 mm high,
for assembly with partition
plates, collet inlay sets, storage
boxes or drilling inlay blocks

fitting to WKS

003, 006, 033, 034, 063, 064

Order No. 2330453 58,00

Dividers

For the individual partition of
your WKH tool trays.

TRB 502/504 (180 x 30 mm)
Order No. 2330356 1,45

TRB 505/506 (180 x 45 mm)
Order No. 2331026 1,76

TRB 903/904 (300 x 30 mm)
Order No. 2330461 1,64



WKH 906

Tool tray for heavy loads
open to one side, easy
handling without lifting

fitting to WKS

005, 009, 034, 064

Order No. 2330764 74,00

Tool trays for Hainbuch collets

With adaption and ground plates for a safe storage.

fitting to WKS
001, 002, 013,
014, 023, 024



WKH 532

for 24 Collets BZI 32

Order No. 2332853 89,00

WKH 520

for 18 Collets BZI 42

Order No. 2331879 89,00

WKH 522

for 18 Collets BZI 52

Order No. 2331880 89,00

WKH 524

for 9 Collets BZI 65

Order No. 2331881 89,00

WKH 528

for 8 Collets BZI 80

Order No. 2331947 89,00

WKH 526

for 5 Collets BZI 100

Order No. 2331882 89,00

fitting to WKS
003, 006, 033,
034, 063, 064



WKH 521

for 24 Collets BZI 42

Order No. 2331883 98,00

WKH 523

for 24 Collets BZI 52

Order No. 2331884 98,00

WKH 525

for 11 Collets BZI 65

Order No. 2331885 98,00

WKH 529

for 10 Collets BZI 80

Order No. 2331946 98,00

WKH 527

for 7 Collets BZI 100

Order No. 2331886 98,00

Inlay units for milling cutters

Made of solid POM material with
practical quad partition for the
sorted storage of milling cutters.

Dim.: 141,5 l x 173 w x 25 h,
fitting to WKH 502, 504, 505, 506.

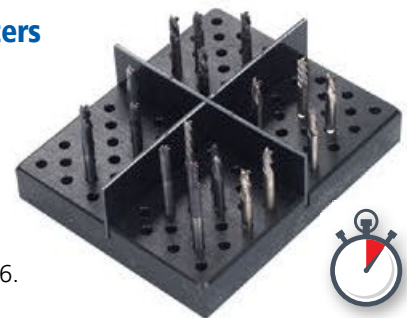

ELE 000 without boreholes

Order No. 2331305 15,00

ELE 031 with 96 boreholes à 3 mm

Order No. 2331943 19,80

ELE 041 with 96 boreholes à 4 mm

Order No. 2331869 19,80

ELE 051 with 96 boreholes à 5 mm

Order No. 2331933 19,80

ELE 061 with 96 boreholes à 6 mm

Order No. 2331286 19,80

ELE 081 with 60 boreholes à 8 mm

Order No. 2331287 19,80

ELE 101 with 60 boreholes à 10 mm

Order No. 2331288 19,80

ELE 121 with 60 boreholes à 12 mm

Order No. 2331870 19,80

ELE 141 with 40 boreholes à 14 mm

Order No. 2331871 19,80

ELE 161 with 40 boreholes à 16 mm

Order No. 2331872 19,80

ELE 181 with 20 boreholes à 18 mm

Order No. 2332047 19,80

ELE 201 with 20 boreholes à 20 mm

Order No. 2331873 19,80

ELE 251 with 8 boreholes à 25 mm

Order No. 2332040 19,80

ELE 321 with 8 boreholes à 32 mm

Order No. 2332041 19,80

ELE 401 with 4 boreholes à 40 mm

Order No. 2332042 19,80

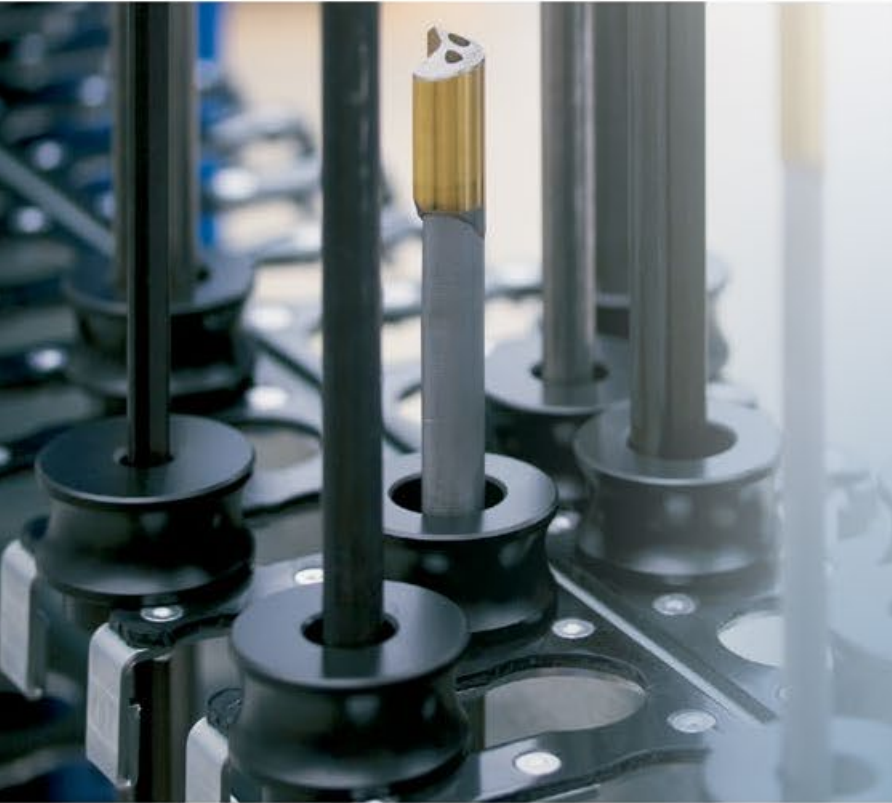

Store your deep hole drills in a professional manner!

Our ingenious storage principal stores up to 520 drills in only one cabinet. The drills are embedded in special floor plates at the drawer bottoms and fixed in the tool carriers with reducing sleeves. So they can be removed easily and quickly at any time. To ensure a comfortable storage, four different reducing sleeves with inner diameters between 10 and 25 mm are available.



Store up
to 520 deep
hole drills on
only 1 m
width



WKS 002 Set B

Store your deep hole drills gently and securely in 5 drawers à 180 mm width with 900 kg payload each incl. 5 tool carriers WKH 602
5 floor plates ELE 850/250 with oil drip pans
50 reducing sleeves (for drills with 25 mm diameter).
1,040 w x 2,140 h x 1,050 d
Order No. 2332931 **3.580,00**

WKS 006 Set B

With 250 mm extended depth
1,040 w x 2,140 h x 1,300 d
Order No. 2332936 **3.980,00**

Separate accessories:

Tool holder WKH 602

Dimensions: 178 w x 860 d x 100 h
fitting to WKS 002

Order No. 2332885 **95,00**

Tool holder WKH 604

Dimensions: 178 w x 1,109 d x 100 h
fitting to WKS 006

Order No. 2332934 **125,00**

Floor plate ELE 850/250

for 80 drills (25 mm diameter)
fitting to WKS 002

Order No. 2332789 **149,00**

Floor plate ELE 1100/250

for 104 drills (25 mm diameter)
fitting to WKS 006

Order No. 2332935 **178,00**

POM reducing sleeves

fitting to WKH 602 and WKH 604,
Outer diameter 40 mm,
Height 15 mm

Inner diameter 10 mm

Order No. 2332880 **3,90**

Inner diameter 15 mm

Order No. 2332886 **3,90**

Inner diameter 20 mm

Order No. 2332887 **3,90**

Inner diameter 25 mm

Order No. 2332888 **3,90**

The material-friendly, safe and clearly arranged storage of your broaches

With the WKS tool cabinet you store your broaches easily accessible and gentle to materials. Due to our special storage system with adjustable crossboards you can store bigger broaches in one row or broaches with smaller diameters in two rows. Plastic covered holding bars enhance smooth gripping and easy handling to protect your valuable tools.



Can also
be provided
for storage on
two rows



WKS 002 Set R Store your broaches gently and securely in 5 drawers à 180 mm width with 900 kg payload each incl. 10 Perforated panels (incl. fixing unit)
50 Holding bars (plastic covered, available in different sizes)
5 Oil drip trays (max. height of broaches 1,750 mm).
1,040 w x 2,140 h x 1,050 d
Order No. 2332781 **3.480,00**

WKS 006 Set R With 250 mm extended depth
1,040 w x 2,140 h x 1,300 d
Order No. 2332780 **3.950,00**

Seperate accessories:

Perforated panels

(incl. fixing unit)

fitting to WKS 002

Order No. 2330077 **59,00**

fitting to WKS 006

Order No. 2330922 **65,00**

Oil drip tray

(incl. wood inlay)

fitting to WKS 002

Order No. 2330267 **74,40**

fitting to WKS 006

Order No. 2330923 **98,00**

Center mount for wooden plate

with boreholes

at your choice

Order No. 2333400 **12,00**

Holding bars

(plastic covered)

width 25 mm

Order No. 2332796 **5,98**

width 50 mm

Order No. 2332797 **6,28**

width 75 mm

Order No. 2332513 **6,58**

width 100 mm

Order No. 2332514 **6,88**



Enhance the possibilities of your lifting system!

Numerous companies of different industries use our flexible all-round programme equipping their lifting systems.

Whether in the spare parts shipment, the tool output or the logistic centre – Apfel components arrange for maximum utilisation of space, suitable tray loading and, therefore, optimal business procedures.

Expand your storage potential and shorten your access times with an individual division and the operating-adapted combination of your different stored goods.



Apfel lift equipment – the complete range of accessories for maximum storage capacity

Slot grid frames with length and cross dividers allow a nearly step-free space segmentation.

With storage boxes in many different sizes you stow away your picking goods and small-parts clearly structured and transport safe.

Tool holders with precise fitted and screwed plastic adapters store cutting tools of all shank types.

With carrier frames you set the storage level of your holders and create space for larger tools.

Use all the storage possibilities of your lifting system and load your trays in order to an efficient and sustainable reducing of your access times!



Storage boxes



Tool holder

Carrier frame sets to raise the storage level of your tool holders

TRG 030-1300

Carrier frame set
Dimensions: 30/80 h x 1,290 l
Order No. 2108042 53,00

TRG 070/1640

Carrier frame set
Dimensions: 70/120 h x 1,630 l
Order No. 2108049 59,00

TRG 070/2060

Carrier frame set
Dimensions: 70/120 h x 2,450 l
Order No. 2108033 64,00

TRG 100/2460

Carrier frame set
Dimensions: 100/150 h x 2,460 l
Order No. 2108134 67,00

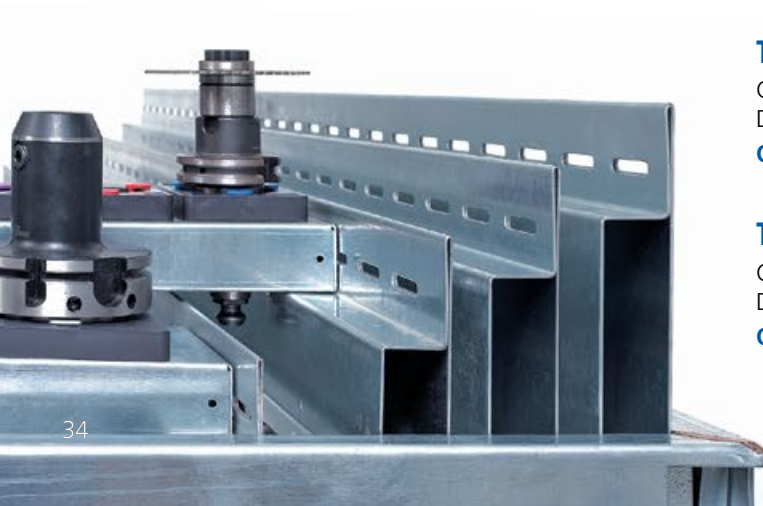

Professional storage of your cutting tools

Due to the precise fit in screw-fastened toolholders your tools will be stored material-friendly and save.

Coloured plastic hooks for the relevant tool types like SK, HSK, VDI, ABS or Capto, ensure a perfect hold and an easy assignment of your tools.

Over 20 different hook combinations in two reception diameters store all relevant cutting tools in your lifting system.

For the storage of collets and special tools we offer a large selection of special tool inlays.



compatible
with lifts of
Megamat, Kardex,
Hänel, SSI, Lista,
Intertex u.a.





compatible with lifts of Megamat, Kardex, Hänel, SSI, Lista, Intertex u.a.

Get your lift going!

Increase your storage potential with the flexible all-round system by Apfel.

Element and carrier frames, tool holders, trenched dividers and storage boxes guarantee customized solutions and optimal use of storage capacity fitting the lifts of all established manufacturers.



Workshop trolleys for cutting tools

With a robust drawer, mountable from both sides, stainless steel handlebar, fixed castors, guided rollers and a payload of 400 kg..



WSW 584 cutting

Incl. 1 even shelf and 4 tool carriers WWR 810

Maße: 582 w x 922 h x 922 d

Order No. 2331242 650,00



































WSW 585 cutting plus

Incl. 1 even shelf, 1 top attachment and 3 tool carriers WWR 810

Maße: 582 w x 1,370 h x 922 d

Order No. 2331243 680,00

Tool carrier		WKT 600		WWR 600	
Dimensions		595 l x 118 w x 50 h		595 l x 118 w x 100 h	
	HSK 40 	8 tools	2108285	8 tools	2108252
	HSK 50 	8 tools	2108286	8 tools	2108253
	HSK 63 	8 tools	2108287	8 tools	2108110
	HSK 63-F 	8 tools	2108289	8 tools	2108288
	HSK 80 	4 tools	2108290	4 tools	2108111
	HSK 100 	4 tools	2108284	4 tools	2108067
	SK 30 	8 tools	2108291 *	8 tools	2108109
	SK 40 	8 tools	2108292 *	8 tools	2108108
	SK 50 	4 tools	2108293 *	4 tools	2108043 *
	Capto C3 	8 tools	2108279 *	8 tools	2108259
	Capto C4 	8 tools	2108280 *	8 tools	2108260
	Capto C5 	8 tools	2108281 *	8 tools	2108261
	Capto C6 	8 tools	2108282 *	8 tools	2108262
	Capto C8 	4 tools	2108283 *	4 tools	2108251
	VDI 20 	8 tools	2108294 *	8 tools	2108254
	VDI 25 	8 tools	2108344 *	8 tools	2108255
	VDI 30 	8 tools	2108347 *	8 tools	2108256
	VDI 40 	8 tools	2108348 *	8 tools	2108257
	VDI 50 	8 tools	2108349 *	8 tools	2108258 *
	VDI 60 	4 tools	2108350 *	4 tools	2108250 *
	ABS 50 	8 tools	2108276 *	8 tools	2108273
	ABS 63 	8 tools	2108277 *	8 tools	2108275
	ABS 80 	7 tools	2108278 *	7 tools	2108274
	UTS 63 	8 tools	2108351 *	8 tools	2108353
	UTS 80 	4 tools	2108352 *	4 tools	2108354
	173 E 	8 tools	2108357 *	8 tools	2108356
Price		61,00		64,00	

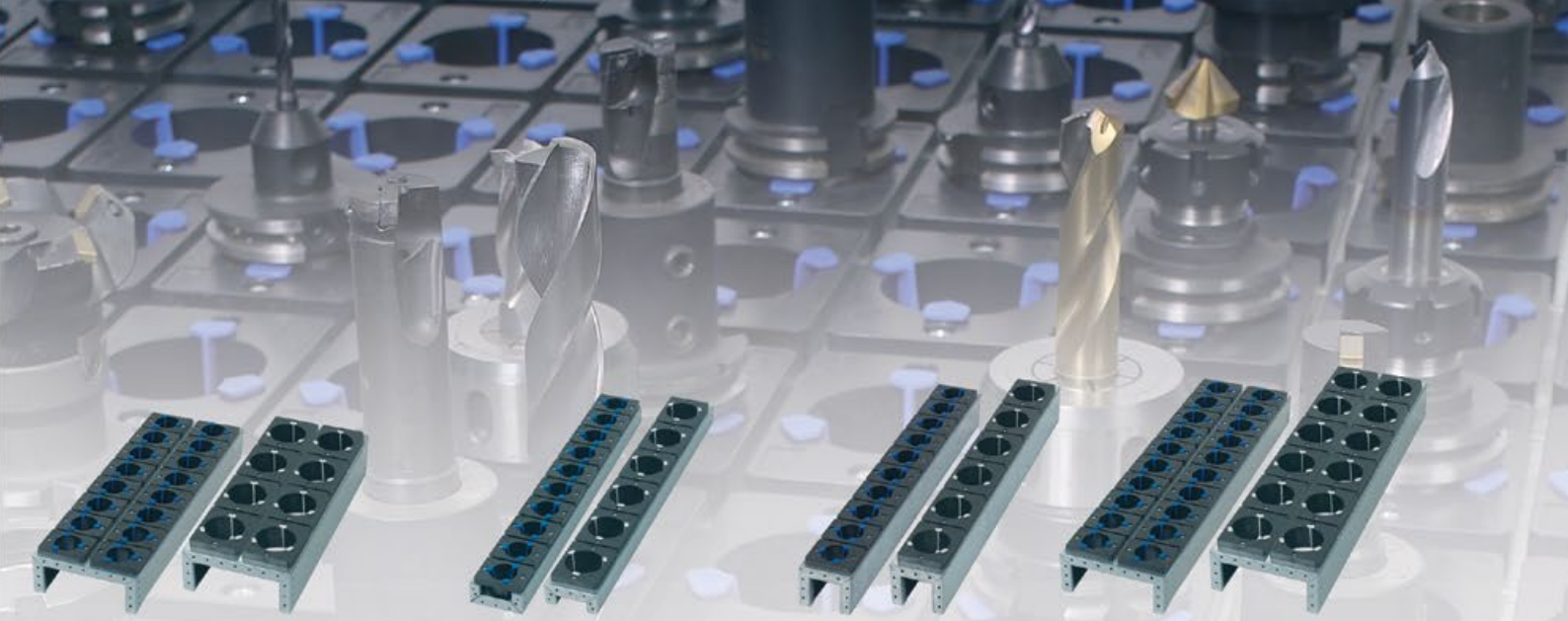

WDR 600		WKT 810		WWR 810		WDR 810	
595 l x 236 w x 100 h		810 l x 118 w x 50 h		810 l x 118 w x 100 h		810 l x 236 w x 100 h	
16 tools	2108393	10 tools	2108216	10 tools	2108230	20 tools	2108297
16 tools	2108394	10 tools	2108269	10 tools	2108195	20 tools	2108298
16 tools	2108395	10 tools	2108208	10 tools	2108194	20 tools	2108199
16 tools	2108396	10 tools	2108270	10 tools	2108266	20 tools	2108265
8 tools	2108397	6 tools	2108217	6 tools	2108244	12 tools	2108342
8 tools	2108398	6 tools	2108215	6 tools	2108203	12 tools	2108343
16 tools	2108399	10 tools	2108218 *	10 tools	2108207	20 tools	2108299
16 tools	2108400	10 tools	2108219 *	10 tools	2108190	20 tools	2108198
8 tools	2108401 *	6 tools	2108220 *	6 tools	2108193 *	12 tools	2108341 *
16 tools	2108402	10 tools	2108271 *	10 tools	2108233	20 tools	2108300
16 tools	2108403	10 tools	2108272 *	10 tools	2108234	20 tools	2108301
16 tools	2108404	10 tools	2108212 *	10 tools	2108232	20 tools	2108302
16 tools	2108405	10 tools	2108213 *	10 tools	2108235	20 tools	2108303
8 tools	2108406	6 tools	2108214 *	6 tools	2108241	12 tools	2108340
16 tools	2108407	10 tools	2108223 *	10 tools	2108231	20 tools	2108304
16 tools	2108408	10 tools	2108224 *	10 tools	2108191	20 tools	2108305
16 tools	2108409	10 tools	2108225 *	10 tools	2108209	20 tools	2108201
16 tools	2108410	10 tools	2108226 *	10 tools	2108205	20 tools	2108200
16 tools	2108411 *	10 tools	2108227 *	10 tools	2108240 *	20 tools	2108307 *
8 tools	2108412 *	6 tools	2108228 *	6 tools	2108243 *	12 tools	2108339 *
16 tools	2108413	10 tools	2108267 *	10 tools	2108237	20 tools	2108308
16 tools	2108414	10 tools	2108210 *	10 tools	2108236	20 tools	2108309
8 tools	2108415	10 tools	2108211 *	10 tools	2108238	20 tools	2108310
16 tools	2108416	10 tools	2108221 *	10 tools	2108239	20 tools	2108311
8 tools	2108417	6 tools	2108222 *	6 tools	2108242	12 tools	2108338
16 tools	2108418	10 tools	2108355 *	10 tools	2108324	20 tools	2108345
92,00		65,00		69,00		98,00	

* to be used only with attachments or heightening



Flexible space sectioning for perfect commissioning

With the special division components for lift systems you stock large quantities of different pieces clearly laid out and needs-oriented.

Screwed dividers in various heights make a high storage volume, length and cross dividers with plugable slot grids arrange for flexibility for the compilation of your shelves.

The user-faced dividers are angled to allow their labeling, the edge of the material is folded to avoid injury.

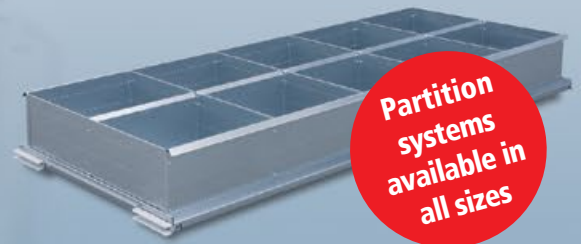

Slot grid system components with 50 mm height

SRR 50-2850

Slot grid frames, complete for lift tray, galvanised sheet steel, 2,850 l x 864 w x 50 h, six-part (long side two-pieces each), pattern 17 mm

Order No. 3733031 **85,00**

LTL 50-826

Length divider for slot grid frames, galvanised sheet steel, 826 l x 50 h, pattern 17 mm

Order No. 3733038 **12,00**

QTL 50-24

Cross divider for slot grid frames, galvanised sheet steel, 405 l x 50 h 32° tilting at 32 mm height

Order No. 3733035 **3,98**

Slot grid system components with 100 mm height

SRR 100-2850

Slot grid frames, complete for lift tray, galvanised sheet steel, 2,850 l x 864 w x 100 h, six-part (long side two-pieces each), pattern 17 mm

Order No. 3733042 **98,00**

LTL 100-826

Length divider for slot grid frames, galvanised sheet steel, 826 l x 100 h, pattern 17 mm

Order No. 3733039 **18,75**

QTL 100-24

Cross divider for slot grid frames, galvanised sheet steel, 405 l x 100 h 45° tilting at 84 mm height

Order No. 3733037 **5,98**



Storage boxes for the individual subdivision of your lift tray

With the precisely bended storage boxes made of metal you organize your lift system to the smallest detail. Optimize your storage areas and reduce your access times.

If made of solid sheet steel or weight-saving aluminum – Apfel storage boxes for optimal usage of space.



Storage boxes in custom sizes and special materials

In addition to our standards made of zinc plated sheet metal (LKV) and aluminum (LKA) in the heights 50, 100, 150 and 200 mm we produce individual sizes and also storage boxes of stainless steel (LKE) for the needs-oriented equipping of your lift.

Storage boxes 1 mm galvanised sheet steel

LKV 50-100/100 50 h x 100 w x 100 l Order No. 2108061 4,00	LKV 50-100/250 50 h x 100 w x 250 l Order No. 2108461 4,65	LKV 50-150/250 50 h x 150 w x 250 l Order No. 2108462 5,10	LKV 50-200/300 50 h x 200 w x 300 l Order No. 2108466 5,85
LKV 50-100/150 50 h x 100 w x 150 l Order No. 2108065 4,20	LKV 50-100/300 50 h x 100 w x 300 l Order No. 2108064 4,90	LKV 50-150/300 50 h x 150 w x 300 l Order No. 2108129 5,40	LKV 50-250/250 50 h x 250 w x 250 l Order No. 2108469 5,90
LKV 50-100/200 50 h x 100 w x 200 l Order No. 2108062 4,45	LKV 50-150/150 50 h x 150 w x 150 l Order No. 2108066 4,50	LKV 50-200/200 50 h x 200 w x 200 l Order No. 2108419 5,15	LKV 50-250/300 50 h x 250 w x 300 l Order No. 2108470 6,35
	LKV 50-150/200 50 h x 150 w x 200 l Order No. 2108122 4,80	LKV 50-200/250 50 h x 200 w x 250 l Order No. 2108465 5,50	LKV 50-300/300 50 h x 300 w x 300 l Order No. 2108442 6,80

Storage boxes 1,5 mm Aluminum (AlMg1)

LKA 50-100/100 50 h x 100 w x 100 l Order No. 2108047 5,60	LKA 50-100/250 50 h x 100 w x 250 l Order No. 2108117 7,50	LKA 50-150/250 50 h x 150 w x 250 l Order No. 2108478 8,60	LKA 50-200/300 50 h x 200 w x 300 l Order No. 2108057 10,70
LKA 50-100/150 50 h x 100 w x 150 l Order No. 2108116 6,20	LKA 50-100/300 50 h x 100 w x 300 l Order No. 2108097 8,15	LKA 50-150/300 50 h x 150 w x 300 l Order No. 2108479 9,40	LKA 50-250/250 50 h x 250 w x 250 l Order No. 2108483 10,85
LKA 50-100/200 50 h x 100 w x 200 l Order No. 2108048 6,85	LKA 50-150/150 50 h x 150 w x 150 l Order No. 2108477 7,00	LKA 50-200/200 50 h x 200 w x 200 l Order No. 2108052 8,80	LKA 50-250/300 50 h x 250 w x 300 l Order No. 2108484 12,00
	LKA 50-150/200 50 h x 150 w x 200 l Order No. 2108130 7,80	LKA 50-200/250 50 h x 200 w x 250 l Order No. 2108481 9,75	LKA 50-300/300 50 h x 300 w x 300 l Order No. 2108487 13,25

Bulk trays – the storage solution with high capacity and flexible division

Sound construction made of 1.5 mm sheet metal. Available for all WKS tool cabinets.

without illustration::

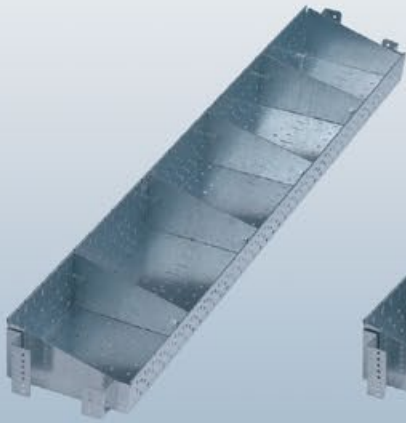

WKH 517

Bulk tray 50 / 90 high
incl. 4 dividers
fitting to WKS
003, 006, 033, 034, 063, 064
Order No. 2331262 39,00

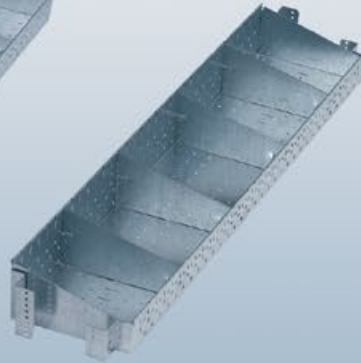

WKH 518

Bulk tray 50 / 90 high
incl. 4 dividers
fitting to WKS
001, 002, 013, 014, 023, 024
Order No. 2331623 35,00



TRB 517/518

Divider 50 / 90 high
fitting to WKH 517 and 518
for screwed fixation,
with joint cut
Order No. 2331263 2,15

WKH 927

bulk tray 50 / 90 high
incl. 4 dividers
fitting to WKS
005, 009, 034, 064
Order No. 2331824 79,00

WKH 928

bulk tray 50 / 90 high
incl. 4 dividers
fitting to WKS
004, 008, 014, 024
Order No. 2331825 69,00

TRB 927/928

Divider 50 / 90 high
fitting to WKH 927 and 928
for screwed fixation,
with joint cut
Order No. 2331900 2,65



WKS 023 Set T

Store large amounts of small parts
at only 660 mm front width.
Incl. 30 bulk trays WKH 518 and
120 dividers TRB 517/518
660 w x 2,140 h x 1,050 d
Order No. 2331826 2.680,00

WKS 063 Set T

With 250 mm extended depth.
Incl. 30 bulk trays WKH 517 and
120 dividers TRB 517/518
660 w x 2,140 h x 1,300 d
Order No. 2331828 2.980,00



Can be
individually
subdivided with
partitions

WKS 002 Set T

Best
Seller

Store up a high volume of stock in
50 bulk trays.
Incl. 50 bulk trays WKH 518 and
200 dividers TRB 517/518
1,040 w x 2,140 h x 1,050 d
Order No. 2331642 3.580,00

WKS 006 Set T

With 250 mm extended depth.
Incl. 50 bulk trays WKH 517 and
200 dividers TRB 517/518
1,040 w x 2,140 h x 1,300 d
Order No. 2331700 3.980,00



plus
250
mm

**WKS 004
Set T
"Panzer"**

The cabinet for tremendous loads with 1,800 kg payload per drawer.

Incl. 30 bulk trays WKH 928 and 120 dividers TRB 927/928

1,040 w x 2,140 h x 1,050 d

Order No. 2331829 4.280,00

**WKS 005
Set T
"Panzer"**

With 250 mm extended depth.

Incl. 30 bulk trays WKH 927 and 120 dividers TRB 927/928

1,040 w x 2,140 h x 1,300 d

Order No. 2331831 4.880,00



plus
250
mm

**WKS 024
Set T**

The cabinet with two drawer sizes.

Incl. 40 bulk trays (30 x WKH 518, 10 x WKH 928) and 160 dividers

1,040 w x 2,140 h x 1,050 d

Order No. 2331707 3.680,00

**WKS 064
Set T**

With 250 mm extended depth.

Incl. 40 bulk trays (30 x WKH 517, 10 x WKH 927), 160 dividers

1,040 w x 2,140 h x 1,300 d

Order No. 2331644 4.180,00

Single row boxes – maximum arrangement and high stability

Perfect seating and extreme payload. Available for all WKS tool cabinets.

Storage bins not included in the tray price. Fitting storage bins on page 72.



WKH 701

Storage tray for 8 storage boxes KLF 211 (No. 11) fitting to WKS 001, 002, 013, 014, 023, 024

Order No. 2330276 43,90



WKH 702

Storage tray for 10 storage boxes KLF 211 (No. 11) fitting to WKS 003, 006, 033, 034, 063, 064

Order No. 2330220 49,90

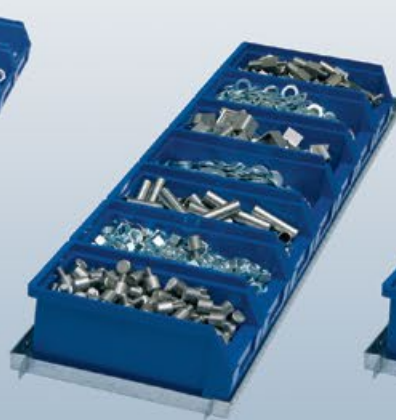

WKH 903

Storage tray for 6 storage boxes KLF 5 (No. 50) fitting to WKS 004, 008, 014, 024

Order No. 2330463 65,00



WKH 904

Storage tray for 7 storage boxes KLF 5 (No. 50) fitting to WKS 005, 009, 034, 064

Order No. 2330464 74,00



WKS 023 Set L

Large amounts of small parts at only 660 mm front width.

Incl. 54 storage trays WKH 701 and 432 storage bins KLF 211 (No. 11)
660 w x 2,140 h x 1,050 d

Order No. 2331837 3.180,00

WKS 063 Set L

With 250 mm extended depth. Incl. 54 storage trays WKH 702 and 540 storage bins KLF 211 (No. 11)
660 w x 2,140 h x 1,300 d

Order No. 2331838 3.680,00



up to 900 storage bins at only 1m front width

WKS 002 Set L

Hundreds of storage bins at minimum floor space.

Incl. 90 storage trays WKH 701 and 720 storage bins KLF 211 (No. 11)
1,040 w x 2,140 h x 1,050 d

Order No. 2331259 4.380,00

WKS 006 Set L

With 250 mm extended depth. Incl. 90 storage trays WKH 702 and 900 storage bins KLF 211 (No. 11)
1,040 w x 2,140 h x 1,300 d

Order No. 2331257 4.980,00

Best Seller



WKS 004
Set L
"Panzer"

The cabinet for tremendous loads with 1,800 kg payload per drawer.
Incl. 30 storage trays WKH 903 and 180 storage bins KLF 5 (No. 50)
1,040 w x 2,140 h x 1,050 d
Order No. 2331840 5.580,00

WKS 005
Set L
"Panzer"

With 250 mm extended depth.
Incl. 30 storage trays WKH 904 and 210 storage bins KLF 5 (No. 50)
1,040 w x 2,140 h x 1,300 d
Order No. 2331839 6.380,00



WKS 024
Set L

The cabinet with two drawer sizes.
Incl. 60 storage trays
(54 x WKH 701, 6 x WKH 901) and 432 storage bins KLF 211 (No. 11)
1,040 w x 2,140 h x 1,050 d
Order No. 2331847 3.980,00

WKS 064
Set L

With 250 mm extended depth.
Incl. 60 storage trays
(54 x WKH 702, 6 x WKH 902) and 540 storage bins KLF 211 (No. 11)
1,040 w x 2,140 h x 1,300 d
Order No. 2331261 4.580,00

Double row boxes – the easy way of Kanban storage!

The clever replenishing system. Available for all WKS tool cabinets.

Storage bins not included in the tray price. Fitting storage bins on page 72.



WKH 502

Tool tray for 16 storage bins
KLF 211 (No. 11)
fitting to WKS
001, 002, 013, 014, 023, 024
Order No. 2330348 49,50



WKH 504

Tool tray for 20 storage bins
KLF 211 (No. 11)
fitting to WKS
003, 006, 033, 034, 063, 064
Order No. 2330452 58,00



WKH 903

Tool tray for 12 storage bins
KLF 5 (No. 50)
fitting to WKS
004, 008, 014, 024
Order No. 2330463 65,00



WKH 904

Tool tray for 14 storage bins
KLF 5 (No. 50)
fitting to WKS
005, 009, 034, 064
Order No. 2330464 74,00



WKS 023 Set L plus

Store your small parts according to Kanban at minimum space.
Incl. 30 storage trays WKH 502 and
480 storage bins KLF 211 (No. 11)
660 w x 2,140 h x 1,050 d
Order No. 2331833 3.580,00

WKS 063 Set L plus

With 250 mm extended depth.
Incl. 30 storage trays WKH 504 and
600 storage bins KLF 211 (No. 11)
660 w x 2,140 h x 1,300 d
Order No. 2331834 4.280,00



WKS 002 Set L plus

Hundreds of storage bins well arranged in compact format.
Incl. 50 storage trays WKH 502 and
800 storage bins KLF 211 (No. 11)
1,040 w x 2,140 h x 1,050 d
Order No. 2331258 4.980,00

WKS 006 Set L plus

With 250 mm extended depth.
Incl. 50 storage trays WKH 504 and
1000 storage bins KLF 211 (No. 11)
1,040 w x 2,140 h x 1,300 d
Order No. 2331246 5.780,00

up to 1,000
storage bins
at only 1m
front width

Best
Seller



**WKS 004
Set L plus
"Panzer"**

The cabinet for tremendous loads with 1,800 kg payload per drawer.
Incl. 18 storage trays WKH 903 and 216 storage bins KLF 5 (No. 50)
1,040 w x 2,140 h x 1,050 d
Order No. 2331835 5.180,00

**WKS 005
Set L plus
"Panzer"**

With 250 mm extended depth.
Incl. 18 storage trays WKH 904 and 252 storage bins KLF 5 (No. 50)
1,040 w x 2,140 h x 1,300 d
Order No. 2331836 5.880,00



**WKS 024
Set L plus**

The cabinet with two drawer sizes.
Incl. 36 storage trays (30 x WKH 502, 6 x WKH 901) and 480 storage bins KLF 211 (No. 11)
1,040 w x 2,140 h x 1,050 d
Order No. 2331788 4.480,00

**WKS 064
Set L plus**

With 250 mm extended depth.
Incl. 36 storage trays (30 x WKH 504, 6 x WKH 902) and 600 storage bins KLF 211 (No. 11)
1,040 w x 2,140 h x 1,300 d
Order No. 2331260 5.180,00

Perforated panels

Maximum storage capacity
at minimum floor space.
Clear arrangement even in
the smallest of rooms.



WKS 002 Set K

WKS 001 Set K

Each perforated panel is usable from both sides and is horizontally adjustable. The panels have a square hole system of 10 x 10 mm combined with a round hole system of 5 mm. (distance from hole to hole is 38 mm horizontally and vertically). The clear usable height is 1,800 or 900 mm, usable depth 850 or 1,100 mm.



plus
250
mm

WKS 001 Set K

Room saving tool storage in compact format with a total storage space of ca. 8 m².

Incl. 5 perforated panels WKH 810
1,040 w x 1,240 h x 1,050 d

Order No. 2331789 2.090,00

WKS 003 Set K

Thanks to 250 mm extended depth storage space of ca. 10 m².

Incl. 5 perforated panels WKH 830
1,040 w x 1,240 h x 1,300 d

Order No. 2331790 2.280,00



plus
250
mm

WKS 002 Set K

About 16 m² of perforated panel result in vast storage capacity at minimum floor space.

Incl. 5 perforated panels WKH 820
1,040 w x 2,140 h x 1,050 d

Order No. 2330826 3.500,00

WKS 006 Set K

Thanks to 250 mm extended depth storage space of ca. 20 m².

Incl. 5 perforated panels WKH 840
1,040 w x 2,140 h x 1,300 d

Order No. 2331228 3.900,00



**WKS 004
Set K
"Panzer"**

Store extremely heavy weight or bulky tools at a total storage space of ca. 9 m².

Incl. 3 perforated panels WKH 820
1,040 w x 2,140 h x 1,050 d

Order No. 2331229 3.400,00

**WKS 005
Set K
"Panzer"**

Thanks to 250 mm extended depth storage space of ca. 12 m².

Incl. 3 perforated panels WKH 840
1,040 w x 2,140 h x 1,300 d

Order No. 2331230 3.800,00



**WKS 024
Set K**

Three conventional drawers and one heavy weight drawer offer a total storage space of ca. 13 m².

Incl. 4 perforated panels WKH 820
1,040 w x 2,140 h x 1,050 d

Order No. 2331482 3.300,00

**WKS 064
Set K**

Thanks to 250 mm extended depth storage space of. 16 m².

Incl. 4 perforated panels WKH 840
1,040 w x 2,140 h x 1,300 d

Order No. 2331483 3.780,00



Perforated panels for cabinet models with 1,050 mm depth

Also fits
WKS 002, 004, 023, 024
as half panel.

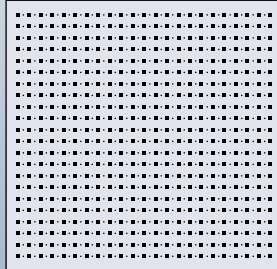

Our perforated tool panels can be used from both sides and are variable to the left and right through knurled nuts and vertically aligned with screws.

The panels have a system of square holes of 10 x 10 mm combined with round holes of 5 mm. The distance from hole center to hole center is 38 mm horizontally and vertically.

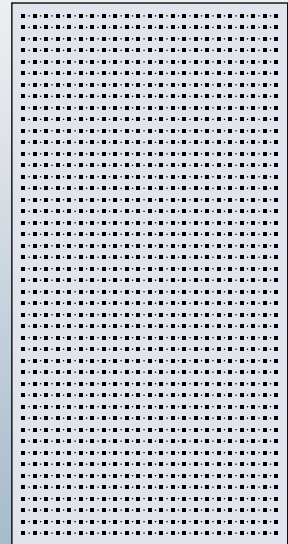

WKH 810

fitting to WKS 001, 008, 013, 014
Dimensions 912 w x 895 h x 26 d

Order No. 2331702 123,00

WKH 820

fitting to WKS 002, 004, 023, 024
Dimensions 912 w x 1,795 h x 26 d

Order No. 2331703 246,00

Hook selection for perforated panels



Hook selection 12 pcs.

- 1 screw wrench holder for 8 wrenches
- 1 screw driver holder for 6 pieces
- 1 drill bit holder for 14 pieces
- 3 tool holders 35 mm
- 1 tong holder 35 mm
- 2 tool holders right angle hook end 75 mm
- 1 tool holder right angle hook end 35 mm
- 1 tool holder right angle hook end 125 mm
- 1 tool holder beveled hook end 50 mm

Order No. 6304681 34,80



Hook selection 40 pcs.

- 1 screw wrench holder
- 1 screw driver holder
- 1 drill bit holder
- 2 saw tool holders for 4 pieces
- 1 tube holder Ø 60 mm
- 1 machine tool holder Ø 40 mm
- 6 tool holders 35 mm
- 3 tong holders 35 mm
- 4 tool holders right angle hook end 75 mm
- 3 tool holders right angle hook end 35 mm
- 4 tool holders right angle hook end 125 mm
- 3 tool holders beveled hook end 50 mm
- 2 tool holders beveled hook end 100 mm
- 3 tool holders beveled hook end 150 mm
- 2 tool holders 2 x beveled hook end 50 mm
- 2 tool holders 2 x right angle hook end 50 mm
- 2 tool holders 2 x straight hook end 50 mm

Order No. 6304685 88,80



Hook selection 18 pcs.

- 1 screw wrench holder
- 1 screw driver holder
- 1 drill bit holder
- 2 saw tool holders for 4 pieces
- 1 machine tool holder Ø 40 mm
- 3 tool holders 35 mm
- 1 tong holder 35 mm
- 2 tool holders right angle hook end 75 mm
- 1 tool holder right angle hook end 35 mm
- 1 tool holder right angle hook end 125 mm
- 1 tool holder beveled hook end 50 mm
- 1 tool holder 2 x beveled hook end 50 mm
- 1 tool holder 2 x right angle hook end 50 mm
- 1 tool holder 2 x straight hook end 50 mm

Order No. 6303432 52,80



Hook selection 50 pcs.

- 1 screw wrench holder
- 1 screw driver holder
- 1 drill bit holder
- 2 saw tool holders for 4 pieces
- 1 tube holder Ø 60 mm
- 2 machine tool holders Ø 40 mm
- 6 tool holders 35 mm
- 3 tong holders 35 mm
- 4 tool holders right angle hook end 75 mm
- 3 tool holders right angle hook end 35 mm
- 4 tool holders right angle hook end 125 mm
- 3 tool holders beveled hook end 50 mm
- 2 tool holders beveled hook end 100 mm
- 2 tool holders beveled hook end 150 mm
- 2 tool holders 2 x beveled hook end 50 mm
- 2 tool holders 2 x right angle hook end 50 mm
- 2 tool holders 2 x straight hook end 50 mm
- 3 tool clamps single 10 mm
- 2 tool clamps single 16 mm
- 2 tool clamps 2 x 10 mm
- 2 tool clamps 2 x 25 mm

Order No. 6304682 115,20



Hook selection 28 pcs.

- 1 screw wrench holder
- 1 screw driver holder
- 1 drill bit holder
- 2 saw tool holders for 4 pieces
- 1 machine tool holder Ø 40 mm
- 6 tool holders 35 mm
- 2 tong holders 35 mm
- 4 tool holders right angle hook end 75 mm
- 3 tool holders right angle hook end 35 mm
- 4 tool holders beveled hook end 50 mm
- 3 tool holders beveled hook end 150 mm

Order No. 6303431 66,00

Perforated panels for cabinet models with 1,300 mm depth

Also fits
WKS 006, 005, 063, 064
as half panel.

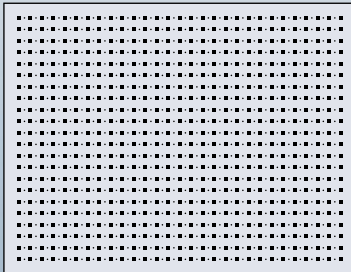

WKH 830

fitting to WKS 003, 009, 033, 034
Dimensions 1,162 w x 895 h x 26 d

Order No. 2331704 **132,00**

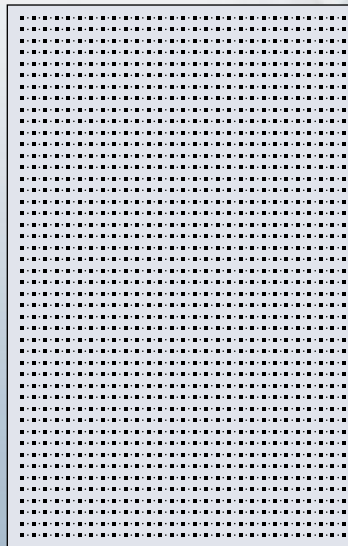

WKH 840

fitting to WKS 006, 005, 063, 064
Dimensions 1,162 w x 1,795 h x 26 d

Order No. 2331705 **279,00**





The tool trolleys for the professional use

Several of our clients use our tool trolleys in their production, because they can be easily and quickly adapted to the individual working conditions.

With hook systems it's easy to organize huge quantities of tools, different materials stowed in the drawers and even the backside of the trolleys is used intensively.

With it's special equipment, our mobile PC trolley is also in action in many companies as a mobile workstation.

Everywhere data is entered, measurements were performed or disorders must be removed, the rolling computer workplace is the ideal assistant in your company.

Both trolley types are powder-coated in blue RAL 5010 (casing) and white RAL 9002 (drawer).

The tool trolley with an integrated adjoining cabinet



Also available in other drawer combinations

Lockable with combination lock



WSL 491

Cabinet with doors and central locking, Incl. drawer with 150 mm h

Dimensions: 567 w x 1,640 h x 702 d

Order No. 2332341

1.480,00

The mobile PC station with complete equipment



Cable retractor, monitor, printer, folders, mouse and keyboard is not included in the price

PCW 700

PC trolley incl. wooden worktop, display panels, document cases, monitor adapter

Dimensions: 720 w x 1,180 / 1,680 h x 922 d

Order No. 1563018

980,00

23054

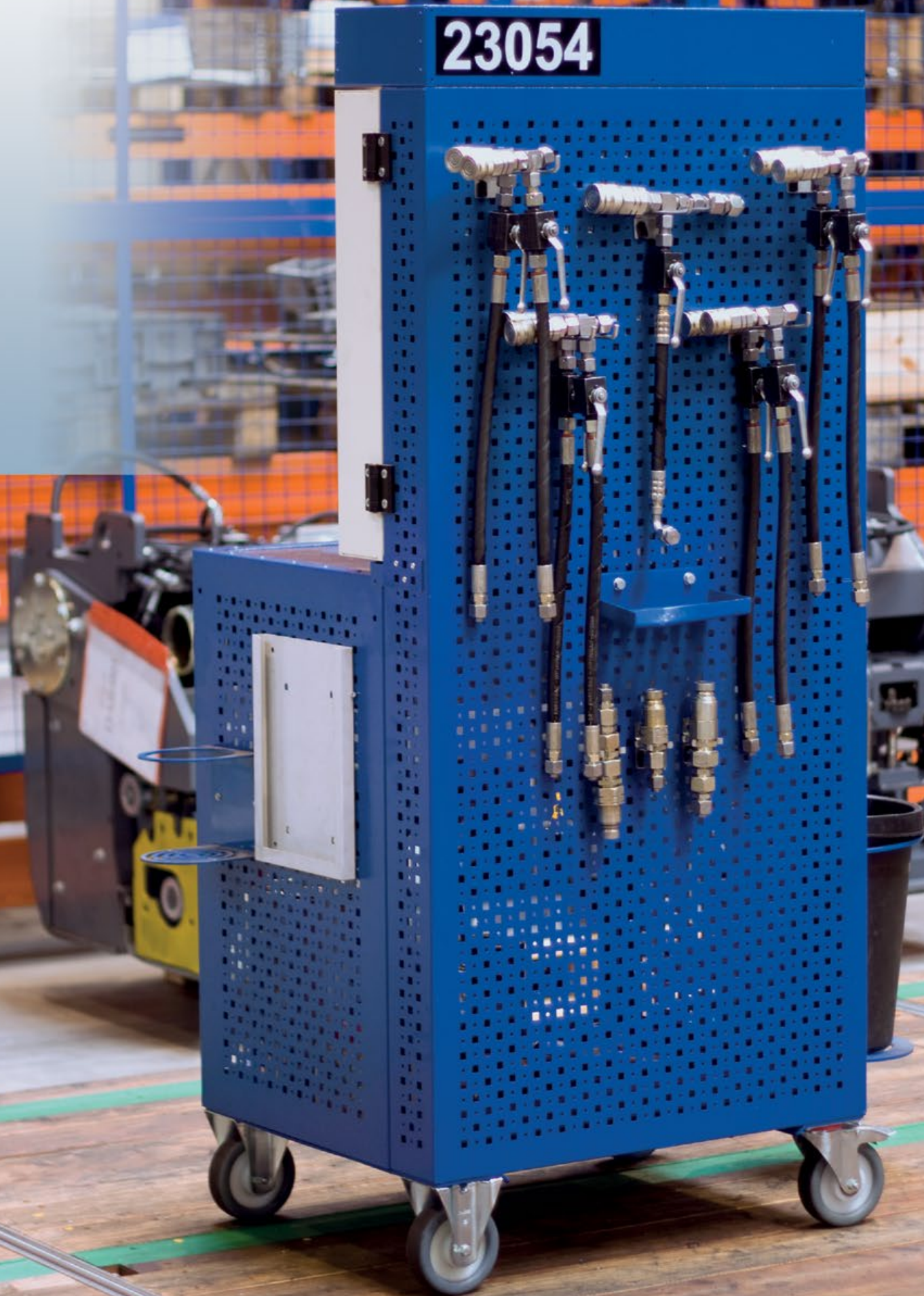



ABI – the multifunctional and space-saving workplace

The Apfel ABI workstation stores various tools, additives and work utilities in even the smallest areas.

Whether it can be used as a flexible workspace in production halls, as a measuring and test station or a complete emergency unit with fire extinguishers and first-aid materials – the ABI allows entire functional units even in niches, passageways or on walls, to improve the organization and the processes in your company.

The workstation is available in three different dimensions and can be individually configured for nearly every imaginable application.

Frame with only 140 mm depth

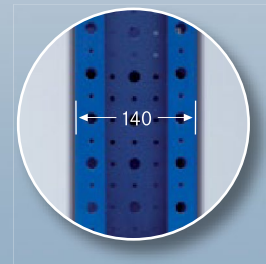

ABI 1125 Basic

Basic module with frame of 3 mm sheet steel including:

- 1 Set mounting plates for floor fixation
- 1 Perforated panel 910 w x 900 h
- 1 Blank space for top board

Dimensions frame ca.:
1,040 w x 2,500 h x 140 d

Order No. 2332534 1.280,00

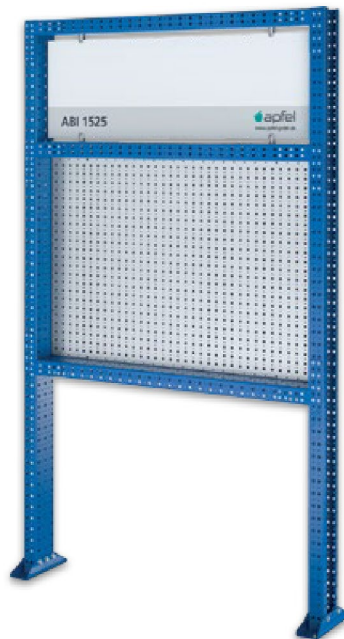

ABI 1525 Basic

Basic module with frame of 3 mm sheet steel including:

- 1 Set mounting plates for floor fixation
- 1 Perforated panel 1,350 w x 900 h
- 1 Blank space for top board

Dimensions frame ca.:
1,490 w x 2,500 h x 140 d

Order No. 2332471 1.360,00



ABI 2025 Basic

Basic module with frame of 3 mm sheet steel including:

- 1 Set mounting plates for floor fixation
- 1 Perforated panel 1,800 w x 900 h
- 1 Blank space for top board

Dimensions frame ca.:
1,940 w x 2,500 h x 140 d

Order No. 2332210 1.480,00

L34

ZV0103



VÖGELE

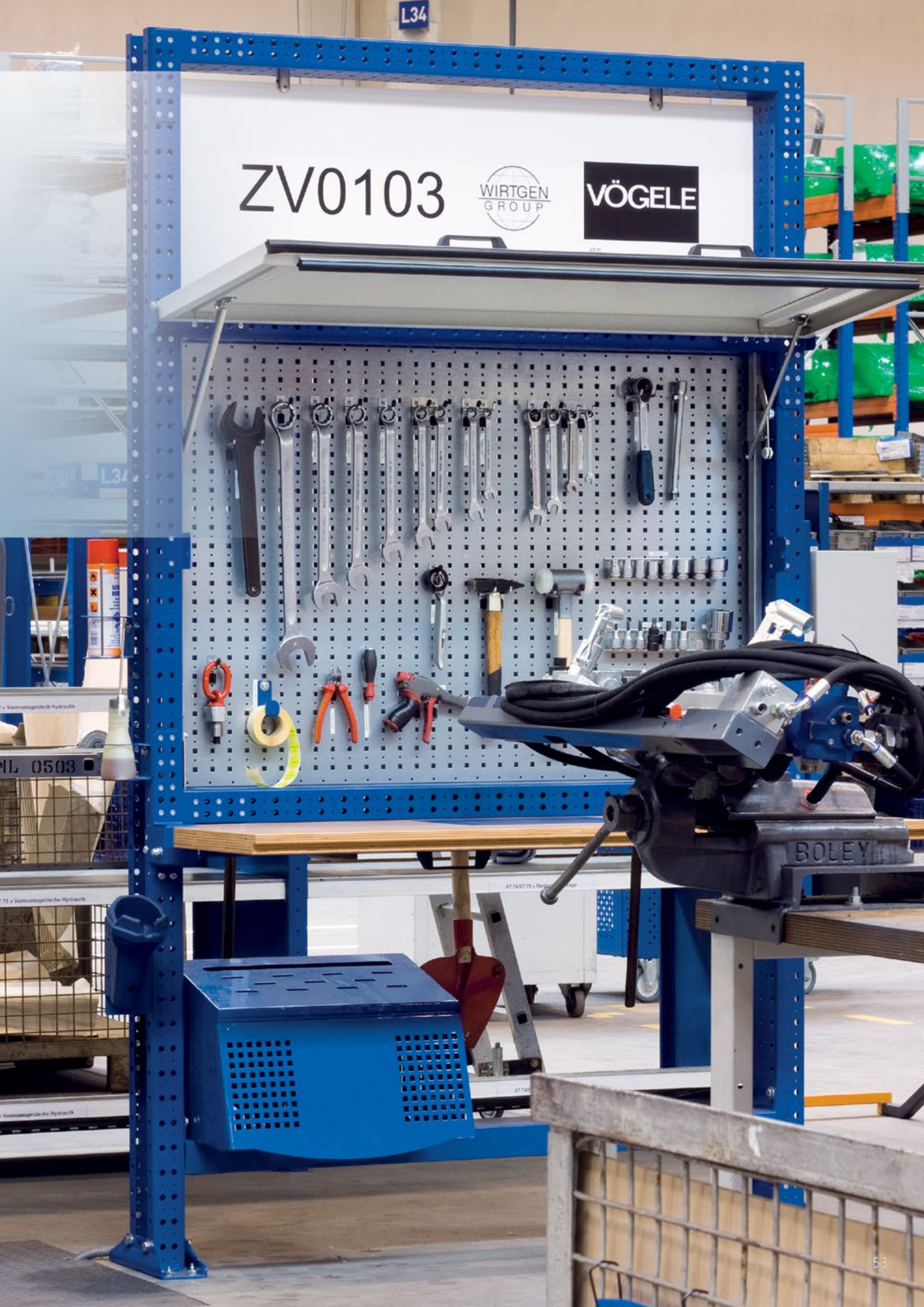

ABI workstations Set K with drop-flap workbench

Complete sets consisting of:

- 1 Frame of 3 mm sheet steel
- 1 Set mounting plates for floor fixation
- 1 Perforated panel usable on both sides
- 1 Blank space for top board
- 1 Drop-flap workbench

Frame powder-coated
in blue (RAL 5010)

Tools, reel-hose, vice-set and
printed top board are not
included in the price

Worktop completely
foldable

Lockable with
combination lock



Quickly to
open with
just a single
movement!



ABI 1125 Set K

The slim version with
lockable drop-flap workbench
Perforated panel 1,040 w x 900 h
Workbench 900 w x 700 d x 40 h
Dimensions frame ca.:
1,040 w x 2,500 h x 140 d

Order No. 2332588 1.650,00



ABI 1525 Set K

The middle-width version
with lockable drop-flap workbench
Perforated panel 1,350 w x 900 h
Workbench 1,350 w x 700 d x 40 h
Dimensions frame ca.:
1,490 w x 2,500 h x 140 d

Order No. 2332390 1.750,00



ABI 2025 Set K

The large version with
lockable drop-flap workbench
Perforated panel 1,800 w x 900 h
Workbench 1,850 w x 700 d x 40 h
Dimensions frame ca.:
1,940 w x 2,500 h x 140 d

Order No. 2332394 1.960,00

ABI workstations Set PC with the complete equipment for your computer workplace

Complete sets consisting of:

- 1 Frame of 3 mm sheet steel
- 1 Set mounting plates for floor fixation
- 1 Perforated panel usable on both sides
- 1 Top board white
- 1 Writing surface with drawer
- 1 Set cases (4 pcs.) for documents size DIN A4
- 4 Document cases
- 1 Mounting adaptor for PC monitors
- 1 Bracket with 10 display panels size 10 DIN A4
- 1 File folder tray (not ABI 1125)
- 1 Printer rack with double paper shelf (not ABI 1125)
- 1 Ballpen box

Frame powder-coated in blue (RAL 5010)

PC, keyboard, telephone, printer and folders
are not included in the price



ABI 1125 Set PC

The slim version as PC station
with complete equipment

Perforated panel 1,040 w x 900 h

Top board 860 w x 440 h

Printable surface 860 w x 300 h

Dimensions frame ca.:

1,040 w x 2,500 h x 140 d

Order No. 2332500 1.950,00



ABI 1525 Set PC

The middle-width version as PC station
with complete equipment

Perforated panel 1,350 w x 900 h

Top board 1,310 w x 440 h

Printable surface 1,310 w x 300 h

Dimensions frame ca.:

1,490 w x 2,500 h x 140 d

Order No. 2332538 2.290,00



ABI 2025 Set PC

The wide version as PC station
with complete equipment

Perforated panel 1,800 w x 900 h

Top board 1,760 b x 440 h

Printable surface 1,760 b x 300 h

Dimensions frame ca.:

1,940 w x 2,500 h x 140 d

Order No. 2332606 2.480,00

Equip your workplace individually to your specifications

With the add-ons and furnishing modules you can fit your ABI workstation individually to your operational needs.

With suitable holders and adapters you mount all modules quickly and easily to your work station and generate a more efficient, space-saving functional unit in order to optimize your operating processes.

Identify various work spaces with the individual design of your ABI workplace with your special lettering and logo.



Individual lettering according to your wishes

ABI top board with individual lettering

Post us your layout, we produce your design according to your specifications. Additional expense for graphic design will be charged on time and material basis.

Top board ABI1125

Dimensions 860 w x 440 h x 4 d
Printable area 860 w x 300 h
One-sided written
Order No. 8500963 218,00
Both-sided written
Order No. 8501008 238,00

Top board ABI1525

Dimensions 1,310 w x 440 h x 4 d
Printable area 1,310 w x 300 h
One-sided written
Order No. 8500899 238,00
Both-sided written
Order No. 8500895 258,00

Top board ABI2025

Dimensions 1,760 w x 440 h x 4 d
Printable area 1,760 w x 300 h
One-sided written
Order No. 8500948 268,00
Both-sided written
Order No. 8500832 298,00



Spring-driven cable reel

Automatic slow rewind of 12 m cable C20 with Euro socket. Robust design in high impact composite material. Frame-mounted swivel bracket with clip fixing and safety lock. Suitable for power tools, hand luminaires etc.

Order No. 2332008 198,00



Spring-driven hose reel

Automatic slow rewind of 8 m of hose H20 5/16". Robust design in high impact composite material. Frame-mounted swivel bracket with clip fixing and safety lock. Suitable for pneumatic tools like pistols, staplers etc.

Order No. 2332007 163,00



Vice-set with adapter plate

Full set composed of:
1 Vice 120 mm with height adjustment
1 Adaptor plate of 4 mm VGA steel

Infinitely height adjustable up to 200 mm, fully rotatable. Equipped with changeable plain and serrated chucks.

Order No. 2332536 390,00



Power bar

Fivefold plug connector

Order No. 2332050 398,00



Fire extinguisher adapter

for fire extinguishers with standard holders

Order No. 2333076 49,00



Waste basket

with cover plate, powder-coated in grayish white RAL 9002 matt, Dimensions when shut: 300 w x 400 h x 200 d

Order No. 2332520 178,00



Storage tray

Multiplex plate for the assembly in the foot area, beech veneer, 20 mm thick.

For ABI 1125 (900 x 490 mm)

Order No. 2332788 100,00

For ABI 1525 (1,350 x 490 mm)

Order No. 2332894 125,00

For ABI 2025 (1,800 x 490 mm)

Order No. 2332922 165,00

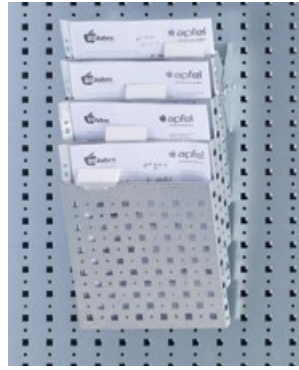

DIN A4 document cases

of zinc-plated perforated sheet.

For documents of DIN A4 size (insertion depth 245 mm).

Including adapter plate.

Order No. 2332542 124,00

For documents of DIN A4 size (single)

Order No. 2332521 19,80

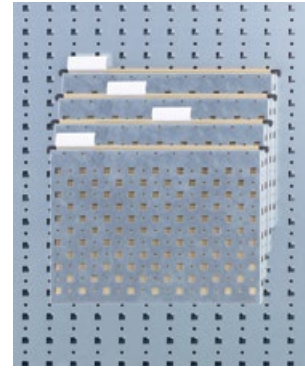

Suspension file cases

of zinc-plated perforated sheet.

For suspension files with plastic tabs.

Including adapter plate.

Order No. 2332543 124,00

Suspension file case (single)

Order No. 2332522 19,80



File folder tray

of zinc-plated perforated sheet.

May also be used as printer rack.

Inner dimensions: 420 w x 200 h x 450 d

Order No. 2332528 98,00



Display panels bracket

with 10 black-bordered display panels, usable on both sides. Tool-free file system with steel pins for a fast and easy exchange. Including mounting bracket for perforated panels.

Order No. 2332589 95,00



Printer rack

of zinc-plated perforated sheet. Suitable to all standard size printers, with double paper shelf underneath the rack

Inner dimensions without paper shelves: 420 w x 200 h x 450 d

Order No. 2332545 115,00



Writing surface

with drawer of zinc-plated perforated sheet, clear height of drawer 25 mm

Dimensions with shut drawer:

490 w x 50/140 h x 350 d

Order No. 2332537 147,00



Paper towel holder

of zinc-plated perforated sheet, dimensions without paper roll:

330 w x 100 h x 100 d

Order No. 2332516 65,00



Workplace lighting

for workstation ABI 1525, incl. 2 plug connectors

Order No. 2332715 88,00

for workstation ABI 2025, incl. 2 plug connectors

Order No. 2332392 98,00



A rugged stainless steel handle bar for a save and solid handling



Both-side rubber lips for a clean and dust-free storage

Series V – the universal storage cabinet for a clean and safe keeping

Numerous widths of the drawers and three different depths of the cabinets offer all possibilities of complete storage systems with an optimal use of available space.

Both-side rubber lips provide clean storage surroundings, stainless steel handle bars an easy and sound handling.

Drawers with running wheels and the solid construction allow payloads of up to 500 kg per drawer.

The overall height of the series V is 2,220, the clear usable height is 1,900 mm, the pattern of the boreholes for the variable mounting of the storage trays is 25 mm.

All Series V models are powder-coated in charcoal gray RAL 7021 (casing) and white RAL 9002 (drawers).

All models are easy to move with a lift truck when empty.



Cabinet versions X with 710 mm width

(VXK, VXS, VXT)

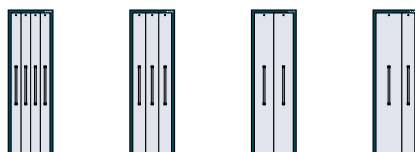

Cabinet versions S with 920 mm width

(VSK, VSS, VST)

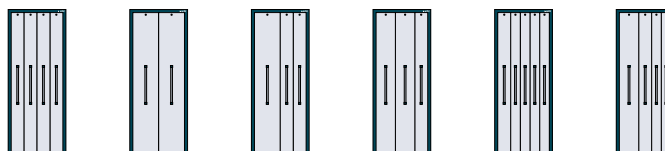

Identity code of
measurements:

Depth (mm)

K = 765

S = 1.135

T = 1.490

Cabinet versions M with 1,025 mm width

(VMK, VMS, VMT)



Cabinet versions L with 1.340 mm width

(VLK, VLS, VLT)

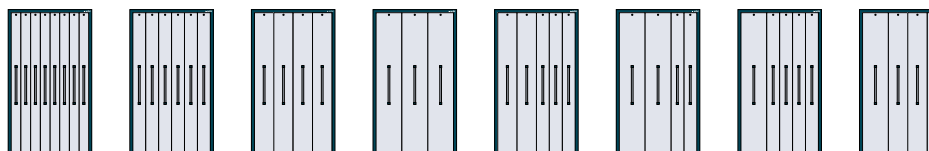

Drawer slide with track rollers for an easy opening and closing



The travelling plastic wheels are also available in ESD-conform version

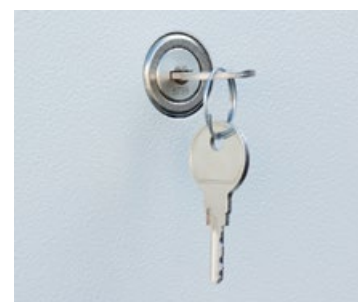

Cylinder lock for the separate interlocking of each drawer



Identity code of measurements:

Width (mm)	Depth (mm)
X = 710	K = 765
S = 920	S = 1,135
M = 1,025	T = 1,490
L = 1,340	

The vertical storage cabinet for individual configuration

Choose your perfect one of our many variants in four different corpus widths and three different depths each.

24 different drawer combinations offer all possibilities to maximize the use of the cabinets volume.

Example: **V L S 3410 Set KFZ**

Width 1,340 mm Depth 1,135 mm

Cabinets with 710 mm width and 1.490 mm depth

VXT 1400 Set unloaded 4 drawers à 150 mm w	Order No. 2333356 2.750,00
VXT 2300 Set unloaded 3 drawers à 200 mm w	Order No. 2333357 2.350,00
VXT 3200 Set unloaded 2 drawers à 300 mm w	Order No. 2333358 1.950,00
VXT 7500 Set unloaded 2 drawers (1 x 400, 1 x 200 mm w)	Order No. 2333359 1.950,00

Cabinets with 920 mm width and 1.490 mm depth

VST 2400 Set unloaded 4 drawers à 200 mm w	Order No. 2333290 2.790,00
VST 4200 Set unloaded 2 drawers à 400 mm w	Order No. 2333291 1.990,00
VST 7600 Set unloaded 3 drawers (1 x 400, 2 x 200 mm w)	Order No. 2333292 2.390,00
VST 7700 Set unloaded 3 drawers (2 x 300, 1 x 200 mm w)	Order No. 2333293 2.390,00
VST 7800 Set unloaded 5 drawers (1 x 200, 4 x 150 mm w)	Order No. 2333294 2.980,00
VST 7900 Set unloaded 4 drawers (1 x 300, 1 x 200, 2 x 150 mm w)	Order No. 2333295 2.790,00

Cabinets with 1.025 mm width and 1.490 mm depth

VMT 1600 Set unloaded 6 drawers à 150 mm w	Order No. 2333144 3.780,00
VMT 3300 Set unloaded 3 drawers à 300 mm w	Order No. 2333145 2.600,00
VMT 8100 Set unloaded 3 drawers (1 x 400, 1 x 300, 1 x 200 mm w)	Order No. 2333146 2.600,00
VMT 8200 Set unloaded 4 drawers (1 x 400, 1 x 200, 2 x 150 mm w)	Order No. 2333147 2.990,00
VMT 8300 Set unloaded 4 drawers (1 x 300, 3 x 200 mm w)	Order No. 2333148 2.990,00
VMT 8400 Set unloaded 5 drawers (3 x 200, 2 x 150 mm w)	Order No. 2333149 3.380,00

Cabinets with 1.340 mm width and 1.490 mm depth

VLT 1800 Set unloaded 8 drawers à 150 mm w	Order No. 2333091 4.680,00
VLT 2600 Set unloaded 6 drawers à 200 mm w	Order No. 2332674 3.280,00
VLT 3400 Set unloaded 4 drawers à 300 mm w	Order No. 2332314 2.980,00
VLT 4300 Set unloaded 3 drawers à 400 mm w	Order No. 2332283 2.680,00
VLT 7100 Set unloaded 5 drawers (2 x 300, 3 x 200 mm w)	Order No. 2332980 3.450,00
VLT 7200 Set unloaded 4 drawers (2 x 400, 2 x 200 mm w)	Order No. 2332842 2.980,00
VLT 7300 Set unloaded 5 drawers (1 x 400, 4 x 200 mm w)	Order No. 2332982 3.450,00
VLT 7400 Set unloaded 4 drawers (1 x 400, 2 x 300, 1 x 200 mm w)	Order No. 2332313 2.980,00

Cabinets with 710 mm width and 1.135 mm depth

VXS 1400 Set unloaded 4 drawers à 150 mm w	Order No. 2333336 2.390,00
VXS 2300 Set unloaded 3 drawers à 200 mm w	Order No. 2333337 1.980,00
VXS 3200 Set unloaded 2 drawers à 300 mm w	Order No. 2333338 1.580,00
VXS 7500 Set unloaded 2 drawers (1 x 400, 1 x 200 mm w)	Order No. 2333339 1.580,00

Cabinets with 920 mm width and 1.135 mm depth

VSS 2400 Set unloaded 4 drawers à 200 mm w	Order No. 2333264 2.390,00
VSS 4200 Set unloaded 2 drawers à 400 mm w	Order No. 2333265 1.650,00
VSS 7600 Set unloaded 3 drawers (1 x 400, 2 x 200 mm w)	Order No. 2333266 2.000,00
VSS 7700 Set unloaded 3 drawers (2 x 300, 1 x 200 mm w)	Order No. 2333267 2.000,00
VSS 7800 Set unloaded 5 drawers (1 x 200, 4 x 150 mm w)	Order No. 2333268 2.780,00
VSS 7900 Set unloaded 4 drawers (1 x 300, 1 x 200, 2 x 150 mm w)	Order No. 2333269 2.390,00

Cabinets with 1.025 mm width and 1.135 mm depth

VMS 1600 Set unloaded 6 drawers à 150 mm w	Order No. 2333138 3.350,00
VMS 3300 Set unloaded 3 drawers à 300 mm w	Order No. 2333139 2.180,00
VMS 8100 Set unloaded 3 drawers (1 x 400, 1 x 300, 1 x 200 mm w)	Order No. 2333140 2.180,00
VMS 8200 Set unloaded 4 drawers (1 x 400, 1 x 200, 2 x 150 mm w)	Order No. 2333141 2.580,00
VMS 8300 Set unloaded 4 drawers (1 x 300, 3 x 200 mm w)	Order No. 2333142 2.580,00
VMS 8400 Set unloaded 5 drawers (3 x 200, 2 x 150 mm w)	Order No. 2333143 2.950,00

Cabinets with 1.340 mm width and 1.135 mm depth

VLS 1800 Set unloaded 8 drawers à 150 mm w	Order No. 2333038 4.250,00
VLS 2600 Set unloaded 6 drawers à 200 mm w	Order No. 2331449 2.950,00
VLS 3400 Set unloaded 4 drawers à 300 mm w	Order No. 2331049 2.750,00
VLS 4300 Set unloaded 3 drawers à 400 mm w	Order No. 2331489 2.650,00
VLS 7100 Set unloaded 5 drawers (2 x 300, 3 x 200 mm w)	Order No. 2331811 2.850,00
VLS 7200 Set unloaded 4 drawers (2 x 400, 2 x 200 mm w)	Order No. 2332497 2.750,00
VLS 7300 Set unloaded 5 drawers (1 x 400, 4 x 200 mm w)	Order No. 2331097 2.850,00
VLS 7400 Set unloaded 4 drawers (1 x 400, 2 x 300, 1 x 200 mm w)	Order No. 2331094 2.750,00

Cabinets with 710 mm width and 765 mm depth

VXK 1400 Set unloaded 4 drawers à 150 mm w	Order No. 2333316 1.980,00
VXK 2300 Set unloaded 3 drawers à 200 mm w	Order No. 2333317 1.680,00
VXK 3200 Set unloaded 2 drawers à 300 mm w	Order No. 2333318 1.390,00
VXK 7500 Set unloaded 2 drawers (1 x 400, 1 x 200 mm w)	Order No. 2333319 1.390,00

Cabinets with 920 mm width and 765 mm depth

VSK 2400 Set unloaded 4 drawers à 200 mm w	Order No. 2333241 2.090,00
VSK 4200 Set unloaded 2 drawers à 400 mm w	Order No. 2333242 1.390,00
VSK 7600 Set unloaded 3 drawers (1 x 400, 2 x 200 mm w)	Order No. 2333244 1.750,00
VSK 7700 Set unloaded 3 drawers (2 x 300, 1 x 200 mm w)	Order No. 2333245 1.750,00
VSK 7800 Set unloaded 5 drawers (1 x 200, 4 x 150 mm w)	Order No. 2333246 2.450,00
VSK 7900 Set unloaded 4 drawers (1 x 300, 1 x 200, 2 x 150 mm w)	Order No. 2333247 2.090,00

Cabinets with 1.025 mm width and 765 mm depth

VMK 1600 Set unloaded 6 drawers à 150 mm w	Order No. 2333132 2.890,00
VMK 3300 Set unloaded 3 drawers à 300 mm w	Order No. 2333133 1.890,00
VMK 8100 Set unloaded 3 drawers (1 x 400, 1 x 300, 1 x 200 mm w)	Order No. 2333077 1.890,00
VMK 8200 Set unloaded 4 drawers (1 x 400, 1 x 200, 2 x 150 mm w)	Order No. 2333135 2.250,00
VMK 8300 Set unloaded 4 drawers (1 x 300, 3 x 200 mm w)	Order No. 2333136 2.250,00
VMK 8400 Set unloaded 5 drawers (3 x 200, 2 x 150 mm w)	Order No. 2333137 2.580,00

Cabinets with 1.340 mm width and 765 mm depth

VLK 1800 Set unloaded 8 drawers à 150 mm w	Order No. 2333094 3.780,00
VLK 2600 Set unloaded 6 drawers à 200 mm w	Order No. 2332958 2.850,00
VLK 3400 Set unloaded 4 drawers à 300 mm w	Order No. 2332976 2.400,00
VLK 4300 Set unloaded 3 drawers à 400 mm w	Order No. 2332977 1.980,00
VLK 7100 Set unloaded 5 drawers (2 x 300, 3 x 200 mm w)	Order No. 2332979 2.750,00
VLK 7200 Set unloaded 4 drawers (2 x 400, 2 x 200 mm w)	Order No. 2332978 2.400,00
VLK 7300 Set unloaded 5 drawers (1 x 400, 4 x 200 mm w)	Order No. 2332981 2.750,00
VLK 7400 Set unloaded 4 drawers (1 x 400, 2 x 300, 1 x 200 mm w)	Order No. 2332858 2.400,00



Set K – The vertical storage cabinet with storage trays

Seven storage trays per drawer (included in delivery) offer lots of space for the storage of various materials.

The solid storage trays, made of galvanized steel, store your boxes, file folders or all other work utilities.

Choose the most suitable option for your requirements from the multitude of our cabinet models with different widths, depth and drawer combinations.

including 7
storage trays
per drawer

Cabinets with 710 mm width and 1.490 mm depth

VXT 1422 Set K 4 drawers à 150 mm w	Order No. 2333368 3.490,00
VXT 2322 Set K 3 drawers à 200 mm w	Order No. 2333369 2.950,00
VXT 3222 Set K 2 drawers à 300 mm w	Order No. 2333370 2.390,00
VXT 7522 Set K 2 drawers (1 x 400, 1 x 200 mm w)	Order No. 2333371 2.390,00

Cabinets with 920 mm width and 1.490 mm depth

VST 2422 Set K 4 drawers à 200 mm w	Order No. 2333303 3.590,00
VST 4222 Set K 2 drawers à 400 mm w	Order No. 2333304 2.450,00
VST 7622 Set K 3 drawers (1 x 400, 2 x 200 mm w)	Order No. 2333305 3.290,00
VST 7722 Set K 3 drawers (2 x 300, 1 x 200 mm w)	Order No. 2333306 3.290,00
VST 7822 Set K 5 drawers (1 x 200, 4 x 150 mm w)	Order No. 2333307 3.150,00
VST 7922 Set K 4 drawers (1 x 300, 1 x 200, 2 x 150 mm w)	Order No. 2333308 3.590,00

Cabinets with 1.025 mm width and 1.490 mm depth

VMT 1622 Set K 6 drawers à 150 mm w	Order No. 2333183 4.950,00
VMT 3322 Set K 3 drawers à 300 mm w	Order No. 2333184 3.250,00
VMT 8122 Set K 3 drawers (1 x 400, 1 x 300, 1 x 200 mm w)	Order No. 2333185 3.250,00
VMT 8222 Set K 4 drawers (1 x 400, 1 x 200, 2 x 150 mm w)	Order No. 2333186 3.790,00
VMT 8322 Set K 4 drawers (1 x 300, 3 x 200 mm w)	Order No. 2333187 3.790,00
VMT 8422 Set K 5 drawers (3 x 200, 2 x 150 mm w)	Order No. 2333188 4.350,00

Cabinets with 1.340 mm width and 1.490 mm depth

VLT 1822 Set K 8 drawers à 150 mm w	Order No. 2333093 5.850,00
VLT 2622 Set K 6 drawers à 200 mm w	Order No. 2332994 4.490,00
VLT 3422 Set K 4 drawers à 300 mm w	Order No. 2332162 3.650,00
VLT 4322 Set K 3 drawers à 400 mm w	Order No. 2332999 3.290,00
VLT 7122 Set K 5 drawers (2 x 300, 3 x 200 mm w)	Order No. 2333056 3.980,00
VLT 7222 Set K 4 drawers (2 x 400, 2 x 200 mm w)	Order No. 2333047 3.650,00
VLT 7322 Set K 5 drawers (1 x 400, 4 x 200 mm w)	Order No. 2333052 3.980,00
VLT 7422 Set K 4 drawers (1 x 400, 2 x 300, 1 x 200 mm w)	Order No. 2333043 3.650,00

Cabinets with 710 mm width and 1.135 mm depth

VXS 1422 Set K 4 drawers à 150 mm w	Order No. 2333344 2.990,00
VXS 2322 Set K 3 drawers à 200 mm w	Order No. 2333345 2.490,00
VXS 3222 Set K 2 drawers à 300 mm w	Order No. 2333346 1.950,00
VXS 7522 Set K 2 drawers (1 x 400, 1 x 200 mm w)	Order No. 2333347 1.950,00

Cabinets with 920 mm width and 1.135 mm depth

VSS 2422 Set K 4 drawers à 200 mm w	Order No. 2333276 2.980,00
VSS 4222 Set K 2 drawers à 400 mm w	Order No. 2333277 1.890,00
VSS 7622 Set K 3 drawers (1 x 400, 2 x 200 mm w)	Order No. 2333278 2.550,00
VSS 7722 Set K 3 drawers (2 x 300, 1 x 200 mm w)	Order No. 2333279 2.550,00
VSS 7822 Set K 5 drawers (1 x 200, 4 x 150 mm w)	Order No. 2333280 3.090,00
VSS 7922 Set K 4 drawers (1 x 300, 1 x 200, 2 x 150 mm w)	Order No. 2333281 2.980,00

Cabinets with 1.025 mm width and 1.135 mm depth

VMS 1622 Set K 6 drawers à 150 mm w	Order No. 2333177 3.980,00
VMS 3322 Set K 3 drawers à 300 mm w	Order No. 2333178 2.750,00
VMS 8122 Set K 3 drawers (1 x 400, 1 x 300, 1 x 200 mm w)	Order No. 2333179 2.750,00
VMS 8222 Set K 4 drawers (1 x 400, 1 x 200, 2 x 150 mm w)	Order No. 2333180 2.980,00
VMS 8322 Set K 4 drawers (1 x 300, 3 x 200 mm w)	Order No. 2333181 2.980,00
VMS 8422 Set K 5 drawers (3 x 200, 2 x 150 mm w)	Order No. 2333182 3.790,00

Cabinets with 1.340 mm width and 1.135 mm depth

VLS 1822 Set K 8 drawers à 150 mm w	Order No. 2333088 5.650,00
VLS 2622 Set K 6 drawers à 200 mm w	Order No. 2331792 3.990,00
VLS 3422 Set K 4 drawers à 300 mm w	Order No. 2332038 3.180,00
VLS 4322 Set K 3 drawers à 400 mm w	Order No. 2332767 2.980,00
VLS 7122 Set K 5 drawers (2 x 300, 3 x 200 mm w)	Order No. 2333055 3.780,00
VLS 7222 Set K 4 drawers (2 x 400, 2 x 200 mm w)	Order No. 2333046 3.180,00
VLS 7322 Set K 5 drawers (1 x 400, 4 x 200 mm w)	Order No. 2333051 3.780,00
VLS 7422 Set K 4 drawers (1 x 400, 2 x 300, 1 x 200 mm w)	Order No. 2332747 3.180,00

Cabinets with 710 mm width and 765 mm depth

VXK 1422 Set K 4 drawers à 150 mm w	Order No. 2333324 2.480,00
VXK 2322 Set K 3 drawers à 200 mm w	Order No. 2333325 1.980,00
VXK 3222 Set K 2 drawers à 300 mm w	Order No. 2333326 1.650,00
VXK 7522 Set K 2 drawers (1 x 400, 1 x 200 mm w)	Order No. 2333327 1.650,00

Cabinets with 920 mm width and 765 mm depth

VSK 2422 Set K 4 drawers à 200 mm w	Order No. 2333252 2.690,00
VSK 4222 Set K 2 drawers à 400 mm w	Order No. 2333253 1.750,00
VSK 7622 Set K 3 drawers (1 x 400, 2 x 200 mm w)	Order No. 2333254 2.250,00
VSK 7722 Set K 3 drawers (2 x 300, 1 x 200 mm w)	Order No. 2333255 2.250,00
VSK 7822 Set K 5 drawers (1 x 200, 4 x 150 mm w)	Order No. 2333256 2.980,00
VSK 7922 Set K 4 drawers (1 x 300, 1 x 200, 2 x 150 mm w)	Order No. 2333257 2.690,00

Cabinets with 1.025 mm width and 765 mm depth

VMK 1622 Set K 6 drawers à 150 mm w	Order No. 2333169 3.790,00
VMK 3322 Set K 3 drawers à 300 mm w	Order No. 2333171 2.390,00
VMK 8122 Set K 3 drawers (1 x 400, 1 x 300, 1 x 200 mm w)	Order No. 2333173 2.390,00
VMK 8222 Set K 4 drawers (1 x 400, 1 x 200, 2 x 150 mm w)	Order No. 2333174 2.890,00
VMK 8322 Set K 4 drawers (1 x 300, 3 x 200 mm w)	Order No. 2333175 2.890,00
VMK 8422 Set K 5 drawers (3 x 200, 2 x 150 mm w)	Order No. 2333176 3.350,00

Cabinets with 1.340 mm width and 765 mm depth

VLK 1822 Set K 8 drawers à 150 mm w	Order No. 2333096 4.990,00
VLK 2622 Set K 6 drawers à 200 mm w	Order No. 2332996 3.890,00
VLK 3422 Set K 4 drawers à 300 mm w	Order No. 2332705 2.980,00
VLK 4322 Set K 3 drawers à 400 mm w	Order No. 2333041 2.490,00
VLK 7122 Set K 5 drawers (2 x 300, 3 x 200 mm w)	Order No. 2333057 3.590,00
VLK 7222 Set K 4 drawers (2 x 400, 2 x 200 mm w)	Order No. 2333045 2.980,00
VLK 7322 Set K 5 drawers (1 x 400, 4 x 200 mm w)	Order No. 2333050 3.590,00
VLK 7422 Set K 4 drawers (1 x 400, 2 x 300, 1 x 200 mm w)	Order No. 2333044 2.980,00



including 5
storage trays
each drawer



Set O – the vertical storage cabinet for file folders

Store up to 300 file folders in only one cabinet!
The vertical drawers with five storage trays each
(included in delivery) allow a quick and easy
access and the maximum use of space, therefore
the Set O is an efficient archiving system.

File folders are not included in delivery.

Cabinets with 710 mm width and 1.490 mm depth	
VXT 3221 Set O 2 drawers à 300 mm w	Order No. 2333372 2.190,00
Cabinets with 1.025 mm width and 1.490 mm depth	
VMT 3321 Set O 3 drawers à 300 mm w	Order No. 2333235 2.990,00
Cabinets with 1.340 mm width and 1.490 mm depth	
VLT 3421 Set O 4 drawers à 300 mm w	Order No. 2332991 3.390,00

Cabinets with 710 mm width and 1.135 mm depth	
VXS 3221 Set O 2 drawers à 300 mm w	Order No. 2333354 1.850,00
Cabinets with 1.025 mm width and 1.135 mm depth	
VMS 3321 Set O 3 drawers à 300 mm w	Order No. 2333234 2.590,00
Cabinets with 1.340 mm width and 1.135 mm depth	
VLS 3421 Set O 4 drawers à 300 mm w	Order No. 2332037 2.980,00

Cabinets with 710 mm width and 765 mm depth	
VXK 3221 Set O 2 drawers à 300 mm w	Order No. 2333335 1.650,00
Cabinets with 1.025 mm width and 765 mm depth	
VMK 3321 Set O 3 drawers à 300 mm w	Order No. 2333233 2.280,00
Cabinets with 1.340 mm width and 765 mm depth	
VLK 3421 Set O 4 drawers à 300 mm w	Order No. 2333115 2.750,00

Best
Seller



including 7
storage trays
each drawer

Set E – the vertical storage cabinet with euro code cases

Store your goods clearly, at hand and
clean in euro code cases.

Seven storage trays per drawer (includ-
ed in delivery) provide space for 14
respectively 21 cases, depending on the
cabinet-depth.

Store up to 84 euro code cases (also
included in delivery) for all conceivable
work materials in just one cabinet!



Euro code case
No. 42
Dimensions:
400 x 300 x 220

Cabinets with 710 mm width and 1.490 mm depth	
VXT 3253 Set E 2 drawers à 300 mm w, 42 cases No. 42	Order No. 2333375 2.550,00
Cabinets with 1.025 mm width and 1.490 mm depth	
VMT 3353 Set E 3 drawers à 300 mm w, 63 cases No. 42	Order No. 2333239 3.490,00
Cabinets with 1.340 mm width and 1.490 mm depth	
VLT 3453 Set E 4 drawers à 300 mm w, 84 cases No. 42	Order No. 2332992 3.990,00

Cabinets with 710 mm width and 1.135 mm depth	
VXS 3253 Set E 2 drawers à 300 mm w, 28 cases No. 42	Order No. 2333355 2.380,00
Cabinets with 1.025 mm width and 1.135 mm depth	
VMS 3353 Set E 3 drawers à 300 mm w, 42 cases No. 42	Order No. 2333236 2.890,00
Cabinets with 1.340 mm width and 1.135 mm depth	
VLS 3453 Set E 4 drawers à 300 mm w, 56 cases No. 42	Order No. 2332039 3.680,00



including 11
storage trays
each drawer

Set K1 – the vertical storage cabinet with boxes

Increase the efficiency of your storage system with our Set K. Host large quantities of small parts on eleven storage trays each drawer (included in delivery) in up to more than 700 boxes in just one cabinet!

The different cabinet models are fully equipped with stable, removable storage bins No. 11 or No. 50.

The storage bins can be labelled and due to their matching fit and extreme payloads they enable an optimal overview and maximum stability!



Bin No. 11
Dimensions:
160 x 100 x 75

Bin No. 50
Dimensions:
290 x 140 x 130



Cabinets with 710 mm width and 1.490 mm depth	
VXT 2351 Set K1	Order No. 2333373
3 drawers à 200 mm w, 363 bins No. 11	3.590,00
VXT 3251 Set K1	Order No. 2333374
2 drawers à 300 mm w, 176 bins No. 50	3.480,00
Cabinets with 920 mm width and 1.490 mm depth	
VST 2451 Set K1	Order No. 2333315
4 drawers à 200 mm w, 484 bins No. 11	4.590,00
Cabinets with 1.025 mm width and 1.490 mm depth	
VMT 3351 Set K1	Order No. 2333238
3 drawers à 300 mm w, 264 bins No. 50	4.900,00
Cabinets with 1.340 mm width and 1.490 mm depth	
VLT 2651 Set K1	Order No. 2332995
6 drawers à 200 mm w, 726 bins No. 11	5.550,00
VLT 3451 Set K1	Order No. 2331149
4 drawers à 300 mm w, 352 bins No. 50	5.980,00

Cabinets with 710 mm width and 1.135 mm depth	
VXS 2351 Set K1	Order No. 2333352
3 drawers à 200 mm w, 297 bins No. 11	2.980,00
VXS 3251 Set K1	Order No. 2333353
2 drawers à 300 mm w, 154 bins No. 50	2.890,00
Cabinets with 920 mm width and 1.135 mm depth	
VSS 2451 Set K1	Order No. 2333289
4 drawers à 200 mm w, 396 bins No. 11	2.950,00
Cabinets with 1.025 mm width and 1.135 mm depth	
VMS 3351 Set K1	Order No. 2333168
3 drawers à 300 mm w, 231 bins No. 50	4.200,00
Cabinets with 1.340 mm width and 1.135 mm depth	
VLS 2651 Set K1	Order No. 2332993
6 drawers à 200 mm w, 594 bins No. 11	4.980,00
VLS 3451 Set K1	Order No. 2331108
4 drawers à 300 mm w, 308 bins No. 50	5.380,00

Cabinets with 710 mm width and 765 mm depth	
VXK 2351 Set K1	Order No. 2333332
3 drawers à 200 mm w, 198 bins No. 11	2.580,00
VXK 3251 Set K1	Order No. 2333334
2 drawers à 300 mm w, 88 bins No. 50	2.350,00
Cabinets with 920 mm width and 765 mm depth	
VSK 2451 Set K1	Order No. 2333288
4 drawers à 200 mm w, 264 bins No. 11	3.350,00
Cabinets with 1.025 mm width and 765 mm depth	
VMK 3351 Set K1	Order No. 2333134
3 drawers à 300 mm w, 132 bins No. 50	3.400,00
Cabinets with 1.340 mm width and 765 mm depth	
VLK 2651 Set K1	Order No. 2332998
6 drawers à 200 mm w, 396 bins No. 11	4.680,00
VLK 3451 Set K1	Order No. 2332990
4 drawers à 300 mm w, 176 bins No. 50	4.350,00



Set S – the vertical storage cabinet with bulk trays

Host large quantities of bulk material and small parts with a perfect overview, always clean and ready to hand in ten bulk trays each drawer (included in delivery).

The solid bulk trays made of sheet steel can be grouped by using dividers which can be fitted easily at grid spacings of 25 mm. So the maximum use of current storage capacities is guaranteed.



**including 10
bulk trays
each drawer**

Cabinets with 710 mm width and 1.490 mm depth	
VXT 1431 Set S 4 drawers à 150 mm w	Order No. 2333364 3.980,00
VXT 2331 Set S 3 drawers à 200 mm w	Order No. 2333365 3.400,00
VXT 3231 Set S 2 drawers à 300 mm w	Order No. 2333366 2.680,00
VXT 7531 Set S 2 drawers (1 x 400, 1 x 200 mm w)	Order No. 2333367 2.680,00
Cabinets with 920 mm width and 1.490 mm depth	
VST 2431 Set S 4 drawers à 200 mm w	Order No. 2333309 3.980,00
VST 4231 Set S 2 drawers à 400 mm w	Order No. 2333310 2.780,00
VST 7631 Set S 3 drawers (1 x 400, 2 x 200 mm w)	Order No. 2333311 3.480,00
VST 7731 Set S 3 drawers (2 x 300, 1 x 200 mm w)	Order No. 2333312 3.480,00
VST 7831 Set S 5 drawers (1 x 200, 4 x 150 mm w)	Order No. 2333313 3.880,00
VST 7931 Set S 4 drawers (1 x 300, 1 x 200, 2 x 150 mm w)	Order No. 2333314 3.980,00
Cabinets with 1.025 mm width and 1.490 mm depth	
VMT 1631 Set S 6 drawers à 150 mm w	Order No. 2333199 4.980,00
VMT 3331 Set S 3 drawers à 300 mm w	Order No. 2333228 3.690,00
VMT 8131 Set S 3 drawers (1 x 400, 1 x 300, 1 x 200 mm w)	Order No. 2333229 3.690,00
VMT 8231 Set S 4 drawers (1 x 400, 1 x 200, 2 x 150 mm w)	Order No. 2333230 3.980,00
VMT 8331 Set S 4 drawers (1 x 300, 3 x 200 mm w)	Order No. 2333231 3.980,00
VMT 8431 Set S 5 drawers (3 x 200, 2 x 150 mm w)	Order No. 2333232 4.580,00
Cabinets with 1.340 mm width and 1.490 mm depth	
VLT 1831 Set S 8 drawers à 150 mm w	Order No. 2333124 6.950,00
VLT 2631 Set S 6 drawers à 200 mm w	Order No. 2333125 5.380,00
VLT 3431 Set S 4 drawers à 300 mm w	Order No. 2333126 3.950,00
VLT 4331 Set S 3 drawers à 400 mm w	Order No. 2333127 3.450,00
VLT 7131 Set S 5 drawers (2 x 300, 3 x 200 mm w)	Order No. 2333128 4.980,00
VLT 7231 Set S 4 drawers (2 x 400, 2 x 200 mm w)	Order No. 2333129 3.980,00
VLT 7331 Set S 5 drawers (1 x 400, 4 x 200 mm w)	Order No. 2333130 4.980,00
VLT 7431 Set S 4 drawers (1 x 400, 2 x 300, 1 x 200 mm w)	Order No. 2333131 3.980,00

Cabinets with 710 mm width and 1.135 mm depth	
VXS 1431 Set S 4 drawers à 150 mm w	Order No. 2333348 3.590,00
VXS 2331 Set S 3 drawers à 200 mm w	Order No. 2333349 2.890,00
VXS 3231 Set S 2 drawers à 300 mm w	Order No. 2333350 2.250,00
VXS 7531 Set S 2 drawers (1 x 400, 1 x 200 mm w)	Order No. 2333351 2.250,00
Cabinets with 920 mm width and 1.135 mm depth	
VSS 2431 Set S 4 drawers à 200 mm w	Order No. 2333282 3.690,00
VSS 4231 Set S 2 drawers à 400 mm w	Order No. 2333283 2.350,00
VSS 7631 Set S 3 drawers (1 x 400, 2 x 200 mm w)	Order No. 2333284 2.980,00
VSS 7731 Set S 3 drawers (2 x 300, 1 x 200 mm w)	Order No. 2333285 2.980,00
VSS 7831 Set S 5 drawers (1 x 200, 4 x 150 mm w)	Order No. 2333286 4.290,00
VSS 7931 Set S 4 drawers (1 x 300, 1 x 200, 2 x 150 mm w)	Order No. 2333287 3.690,00
Cabinets with 1.025 mm width and 1.135 mm depth	
VMS 1631 Set S 6 drawers à 150 mm w	Order No. 2333193 4.980,00
VMS 3331 Set S 3 drawers à 300 mm w	Order No. 2333194 2.980,00
VMS 8131 Set S 3 drawers (1 x 400, 1 x 300, 1 x 200 mm w)	Order No. 2333195 2.980,00
VMS 8231 Set S 4 drawers (1 x 400, 1 x 200, 2 x 150 mm w)	Order No. 2333196 3.780,00
VMS 8331 Set S 4 drawers (1 x 300, 3 x 200 mm w)	Order No. 2333197 3.780,00
VMS 8431 Set S 5 drawers (3 x 200, 2 x 150 mm w)	Order No. 2333198 3.980,00
Cabinets with 1.340 mm width and 1.135 mm depth	
VLS 1831 Set S 8 drawers à 150 mm w	Order No. 2333116 5.950,00
VLS 2631 Set S 6 drawers à 200 mm w	Order No. 2333117 4.850,00
VLS 3431 Set S 4 drawers à 300 mm w	Order No. 2333118 3.990,00
VLS 4331 Set S 3 drawers à 400 mm w	Order No. 2333119 3.690,00
VLS 7131 Set S 5 drawers (2 x 300, 3 x 200 mm w)	Order No. 2333120 4.490,00
VLS 7231 Set S 4 drawers (2 x 400, 2 x 200 mm w)	Order No. 2333121 3.990,00
VLS 7331 Set S 5 drawers (1 x 400, 4 x 200 mm w)	Order No. 2333122 4.490,00
VLS 7431 Set S 4 drawers (1 x 400, 2 x 300, 1 x 200 mm w)	Order No. 2333123 3.990,00

Cabinets with 710 mm width and 765 mm depth	
VXK 1431 Set S 4 drawers à 150 mm w	Order No. 2333328 2.980,00
VXK 2331 Set S 3 drawers à 200 mm w	Order No. 2333329 2.550,00
VXK 3231 Set S 2 drawers à 300 mm w	Order No. 2333330 1.950,00
VXK 7531 Set S 2 drawers (1 x 400, 1 x 200 mm w)	Order No. 2333331 1.950,00
Cabinets with 920 mm width and 765 mm depth	
VSK 2431 Set S 4 drawers à 200 mm w	Order No. 2333258 2.980,00
VSK 4231 Set S 2 drawers à 400 mm w	Order No. 2333259 1.990,00
VSK 7631 Set S 3 drawers (1 x 400, 2 x 200 mm w)	Order No. 2333260 2.650,00
VSK 7731 Set S 3 drawers (2 x 300, 1 x 200 mm w)	Order No. 2333261 2.650,00
VSK 7831 Set S 5 drawers (1 x 200, 4 x 150 mm w)	Order No. 2333262 3.850,00
VSK 7931 Set S 4 drawers (1 x 300, 1 x 200, 2 x 150 mm w)	Order No. 2333263 2.980,00
Cabinets with 1.025 mm width and 765 mm depth	
VMK 1631 Set S 6 drawers à 150 mm w	Order No. 2333170 3.980,00
VMK 3331 Set S 3 drawers à 300 mm w	Order No. 2333172 2.790,00
VMK 8131 Set S 3 drawers (1 x 400, 1 x 300, 1 x 200 mm w)	Order No. 2333189 2.790,00
VMK 8231 Set S 4 drawers (1 x 400, 1 x 200, 2 x 150 mm w)	Order No. 2333190 3.390,00
VMK 8331 Set S 4 drawers (1 x 300, 3 x 200 mm w)	Order No. 2333191 3.390,00
VMK 8431 Set S 5 drawers (3 x 200, 2 x 150 mm w)	Order No. 2333192 3.850,00
Cabinets with 1.340 mm width and 765 mm depth	
VLK 1831 Set S 8 drawers à 150 mm w	Order No. 2333097 5.750,00
VLK 2631 Set S 6 drawers à 200 mm w	Order No. 2333108 4.680,00
VLK 3431 Set S 4 drawers à 300 mm w	Order No. 2333109 3.650,00
VLK 4331 Set S 3 drawers à 400 mm w	Order No. 2333110 2.980,00
VLK 7131 Set S 5 drawers (2 x 300, 3 x 200 mm w)	Order No. 2333111 3.980,00
VLK 7231 Set S 4 drawers (2 x 400, 2 x 200 mm w)	Order No. 2333112 3.650,00
VLK 7331 Set S 5 drawers (1 x 400, 4 x 200 mm w)	Order No. 2333113 3.980,00
VLK 7431 Set S 4 drawers (1 x 400, 2 x 300, 1 x 200 mm w)	Order No. 2333114 3.650,00



Set KFZ – the vertical storage cabinet with perforated panels

With our Set KFZ you store your tools space-saving and clearly arranged.

The perforated panels of our Set KFZ can be used on both sides to offer total storage areas up to 37 m² at relatively low footprint!

Various hook selections for a professional storage of your tools can be found on page 48.

Tools and hooks are not included in delivery.

Cabinets with 710 mm width and 1.490 mm depth	
VXT 1410 Set KFZ 4 drawers à 150 mm w	Order No. 2333360 3.890,00
VXT 2310 Set KFZ 3 drawers à 200 mm w	Order No. 2333361 3.190,00
VXT 3210 Set KFZ 2 drawers à 300 mm w	Order No. 2333362 2.490,00
VXT 7510 Set KFZ 2 drawers (1 x 400, 1 x 200 mm w)	Order No. 2333363 2.490,00
Cabinets with 920 mm width and 1.490 mm depth	
VST 2410 Set KFZ 4 drawers à 200 mm w	Order No. 2333296 3.690,00
VST 4210 Set KFZ 2 drawers à 400 mm w	Order No. 2333297 2.550,00
VST 7610 Set KFZ 3 drawers (1 x 400, 2 x 200 mm w)	Order No. 2333298 3.190,00
VST 7710 Set KFZ 3 drawers (2 x 300, 1 x 200 mm w)	Order No. 2333299 3.190,00
VST 7810 Set KFZ 5 drawers (1 x 200, 4 x 150 mm w)	Order No. 2333301 3.990,00
VST 7910 Set KFZ 4 drawers (1 x 300, 1 x 200, 2 x 150 mm w)	Order No. 2333302 3.890,00
Cabinets with 1.025 mm width and 1.490 mm depth	
VMT 1610 Set KFZ 6 drawers à 150 mm w	Order No. 2333162 4.970,00
VMT 3310 Set KFZ 3 drawers à 300 mm w	Order No. 2333163 3.450,00
VMT 8110 Set KFZ 3 drawers (1 x 400, 1 x 300, 1 x 200 mm w)	Order No. 2333164 3.450,00
VMT 8210 Set KFZ 4 drawers (1 x 400, 1 x 200, 2 x 150 mm w)	Order No. 2333165 3.990,00
VMT 8310 Set KFZ 4 drawers (1 x 300, 3 x 200 mm w)	Order No. 2333166 3.990,00
VMT 8410 Set KFZ 5 drawers (3 x 200, 2 x 150 mm w)	Order No. 2333167 4.790,00
Cabinets with 1.340 mm width and 1.490 mm depth	
VLT 1810 Set KFZ 8 drawers à 150 mm w	Order No. 2333092 5.980,00
VLT 2610 Set KFZ 6 drawers à 200 mm w	Order No. 2332987 4.990,00
VLT 3410 Set KFZ 4 drawers à 300 mm w	Order No. 2332864 3.980,00
VLT 4310 Set KFZ 3 drawers à 400 mm w	Order No. 2333040 3.490,00
VLT 7110 Set KFZ 5 drawers (2 x 300, 3 x 200 mm w)	Order No. 2333053 4.890,00
VLT 7210 Set KFZ 4 drawers (2 x 400, 2 x 200 mm w)	Order No. 2332259 3.980,00
VLT 7310 Set KFZ 5 drawers (1 x 400, 4 x 200 mm w)	Order No. 2333049 4.850,00
VLT 7410 Set KFZ 4 drawers (1 x 400, 2 x 300, 1 x 200 mm w)	Order No. 2331150 3.980,00

Cabinets with 710 mm width and 1.135 mm depth	
VXS 1410 Set KFZ 4 drawers à 150 mm w	Order No. 2333340 3.390,00
VXS 2310 Set KFZ 3 drawers à 200 mm w	Order No. 2333341 2.690,00
VXS 3210 Set KFZ 2 drawers à 300 mm w	Order No. 2333342 1.990,00
VXS 7510 Set KFZ 2 drawers (1 x 400, 1 x 200 mm w)	Order No. 2333343 1.990,00
Cabinets with 920 mm width and 1.135 mm depth	
VSS 2410 Set KFZ 4 drawers à 200 mm w	Order No. 2333270 3.390,00
VSS 4210 Set KFZ 2 drawers à 400 mm w	Order No. 2333271 2.150,00
VSS 7610 Set KFZ 3 drawers (1 x 400, 2 x 200 mm w)	Order No. 2333272 2.750,00
VSS 7710 Set KFZ 3 drawers (2 x 300, 1 x 200 mm w)	Order No. 2333273 2.750,00
VSS 7810 Set KFZ 5 drawers (1 x 200, 4 x 150 mm w)	Order No. 2333274 3.750,00
VSS 7910 Set KFZ 4 drawers (1 x 300, 1 x 200, 2 x 150 mm w)	Order No. 2333275 3.390,00
Cabinets with 1.025 mm width and 1.135 mm depth	
VMS 1610 Set KFZ 6 drawers à 150 mm w	Order No. 2333156 4.790,00
VMS 3310 Set KFZ 3 drawers à 300 mm w	Order No. 2333157 2.890,00
VMS 8110 Set KFZ 3 drawers (1 x 400, 1 x 300, 1 x 200 mm w)	Order No. 2333158 2.890,00
VMS 8210 Set KFZ 4 drawers (1 x 400, 1 x 200, 2 x 150 mm w)	Order No. 2333159 3.580,00
VMS 8310 Set KFZ 4 drawers (1 x 300, 3 x 200 mm w)	Order No. 2333160 3.580,00
VMS 8410 Set KFZ 5 drawers (3 x 200, 2 x 150 mm w)	Order No. 2333161 4.190,00
Cabinets with 1.340 mm width and 1.135 mm depth	
VLS 1810 Set KFZ 8 drawers à 150 mm w	Order No. 2332807 5.850,00
VLS 2610 Set KFZ 6 drawers à 200 mm w	Order No. 2332031 4.380,00
VLS 3410 Set KFZ 4 drawers à 300 mm w	Order No. 2332032 3.750,00
VLS 4310 Set KFZ 3 drawers à 400 mm w	Order No. 2332033 3.400,00
VLS 7110 Set KFZ 5 drawers (2 x 300, 3 x 200 mm w)	Order No. 2332035 3.900,00
VLS 7210 Set KFZ 4 drawers (2 x 400, 2 x 200 mm w)	Order No. 2332036 3.750,00
VLS 7310 Set KFZ 5 drawers (1 x 400, 4 x 200 mm w)	Order No. 2332034 3.900,00
VLS 7410 Set KFZ 4 drawers (1 x 400, 2 x 300, 1 x 200 mm w)	Order No. 2331099 3.750,00

Cabinets with 710 mm width and 765 mm depth	
VXK 1410 Set KFZ 4 drawers à 150 mm w	Order No. 2333320 2.880,00
VXK 2310 Set KFZ 3 drawers à 200 mm w	Order No. 2333321 2.350,00
VXK 3210 Set KFZ 2 drawers à 300 mm w	Order No. 2333322 1.790,00
VXK 7510 Set KFZ 2 drawers (1 x 400, 1 x 200 mm w)	Order No. 2333323 1.790,00
Cabinets with 920 mm width and 765 mm depth	
VSK 2410 Set KFZ 4 drawers à 200 mm w	Order No. 2333240 2.990,00
VSK 4210 Set KFZ 2 drawers à 400 mm w	Order No. 2333243 1.790,00
VSK 7610 Set KFZ 3 drawers (1 x 400, 2 x 200 mm w)	Order No. 2333248 2.390,00
VSK 7710 Set KFZ 3 drawers (2 x 300, 1 x 200 mm w)	Order No. 2333249 2.390,00
VSK 7810 Set KFZ 5 drawers (1 x 200, 4 x 150 mm w)	Order No. 2333250 3.550,00
VSK 7910 Set KFZ 4 drawers (1 x 300, 1 x 200, 2 x 150 mm w)	Order No. 2333251 2.990,00
Cabinets with 1.025 mm width and 765 mm depth	
VMK 1610 Set KFZ 6 drawers à 150 mm w	Order No. 2333150 3.900,00
VMK 3310 Set KFZ 3 drawers à 300 mm w	Order No. 2333151 2.550,00
VMK 8110 Set KFZ 3 drawers (1 x 400, 1 x 300, 1 x 200 mm w)	Order No. 2333152 2.550,00
VMK 8210 Set KFZ 4 drawers (1 x 400, 1 x 200, 2 x 150 mm w)	Order No. 2333153 3.150,00
VMK 8310 Set KFZ 4 drawers (1 x 300, 3 x 200 mm w)	Order No. 2333154 3.150,00
VMK 8410 Set KFZ 5 drawers (3 x 200, 2 x 150 mm w)	Order No. 2333155 3.690,00
Cabinets with 1.340 mm width and 765 mm depth	
VLK 1810 Set KFZ 8 drawers à 150 mm w	Order No. 2333095 4.980,00
VLK 2610 Set KFZ 6 drawers à 200 mm w	Order No. 2331105 3.980,00
VLK 3410 Set KFZ 4 drawers à 300 mm w	Order No. 2332989 3.200,00
VLK 4310 Set KFZ 3 drawers à 400 mm w	Order No. 2333042 2.590,00
VLK 7110 Set KFZ 5 drawers (2 x 300, 3 x 200 mm w)	Order No. 2333054 3.850,00
VLK 7210 Set KFZ 4 drawers (2 x 400, 2 x 200 mm w)	Order No. 2332735 3.290,00
VLK 7310 Set KFZ 5 drawers (1 x 400, 4 x 200 mm w)	Order No. 2333048 3.850,00
VLK 7410 Set KFZ 4 drawers (1 x 400, 2 x 300, 1 x 200 mm w)	Order No. 2331151 3.290,00



Sorting and moving with Apfel load carriers

With our load carriers you make the transfer of your individually combined goods easy, fast and save. Prepare all needed components for your projects on the spot to ensure more loading safety and a precise classification.

With the both-sided access to your goods you use the optimum of your loading area and commission many different products in the tightest of spaces.



With access to the goods on both sides



Completely premounted, including 80 boxes

TKP 774 load carrier

Completely premounted on a pallet, incl. 4 shelves and 50 storage bins No. 13
 Dim.: 773 w x 1,160 h x 1,100 d
Order No. 2332791 580,00

RSP 777 load carrier

Completely premounted on a pallet, incl. 7 shelves and 80 storage bins No. 13
 Dim.: 773 w x 1,950 h x 1,100 d
Order No. 2332795 890,00

The storage system for all operation processes



With optimal loading gauge for trucks

The wheeled shelf cabinets in in-line construction allow a functional and well-arranged system, also for large amounts of stock in your company.

Wheeled shelf cabinets

All RSW wheeled shelf cabinets are powder-coated gray RAL 7021 and equipped with:

2 x stainless steel handlebar
2 x fixed castors Ø 125 mm
2 x guided rollers Ø 125 mm with brakes

Dimensions:
773 w x 1,950 h x 1,100 t
Total payload 400 kg



Doors for assembly from both sides with snap closing hinges



Collection pan for the safe storage of liquids

RAT 773

Two-part door, with locking device, snap closing hinges
RAL 9002 powder-coated
Order No. 2330824 159,00

RAW 773

stainless steel collection pan for liquids, collection volume ca. 70 litres
690 w x 1,090 d x 100 h
Order No. 2330328 99,00



RSW 774

Basic model,
incl. 2 even shelves
Order No. 2332059 390,00



RSW 775

incl. 4 even shelves
(file folders not included)
Order No. 2332048 440,00



RSW 776

incl. 4 even shelves and
100 storage bins No. 13
Order No. 2332060 890,00



RSW 777

incl. 7 even shelves and
80 storage bins No. 13
Order No. 2332061 890,00

Storing, sorting and filling with Apfel transport carts

The multifunctional storage and transport carts for all kinds of material and equipment.

Compose your individual storage and logistic system according to your operational requirements thanks to various chassis.



Workshop trolleys

All WSW workshop trolleys are powder-coated gray RAL 7021 (corpus) white RAL 9002 (drawer) and equipped with:

- 1 x drawer one-way
- 1 x stainless steel handlebar
- 2 x fixed castors Ø 125 mm
- 2 x guided rollers Ø 125 mm with brakes

Dimensions:
580 w x 922 h x 922d
(with attachment 1,265 h)
Total payload 400 kg



WSW 580

Basic model
incl. 1 even shelf
and rubber mat
Order No. 2332054 385,00



WSW 586 "storing"

incl. 2 sloped and 3 slim shelves, 20 storage bins No. 13, 24 storage bins No. 11
Order No. 2332055 690,00

Transport and Commissioning Carts

All TKW commissioning carts are powder-coated gray RAL 7021 and equipped with:

- 1 x stainless steel handlebar
- 2 x fixed castors Ø 125 mm
- 2 x guided rollers Ø 125 mm with brakes

Dimensions:
773 w x 1,160 h x 1,100 d
Total payload 400 kg



TKW 771

Basic model
incl. 2 even shelves
Order No. 2332056 350,00



TKW 772

incl. 2 even shelves
and 60 storage bins No. 13
Order No. 2332057 580,00



TKW 774

incl. 4 even shelves
and 50 storage bins No. 13
Order No. 2332058 580,00

Create tidiness at your company in no time at all and fill up your coolants clean, fast and safe

With the Apfel cleaning station your cleansing material is available all the time and everywhere. The practically shadowboards give a clear guidance for the stock positions. So everything is easy to find and always at its place. Four steering rollers with integrated brakes enhance a perfect handling and the highest security.

Also the Apfel coolants cart with two smooth running block rollers and two steering rollers with brakes ensure easy operation and highest safety standards. Mix up to 800 liters of coolant directly where you need it – on the machine. If the canister is empty, it can be replaced easily.

RGS 5000 Cleaning station

Fully assembled including:
2 shelves KRB 4700
1 storage cases No. 62
2 storage cases No. 42
1 Waste basket of zinc sheet
2 brushes
1 scrubbing brush
1 dustpan
1 set shadowboards
1 board for cleaning products
4 steering rollers with brake
corpus powder-coated
gray RAL 7021.
Static payload max. 400 kg
Dim.: 512 w x 1,952 h x 772 d
Order No. 2332126 649,00



KMW 4000 Coolants cart

Fully assembled including:
1 drawer
1 shelf
1 hose reel
1 mixing valve holder
1 board for cleaning products
1 paper towel holder
1 scrubbing brush
1 dustpan
1 set shadowboards
2 steering rollers with brake
2 block rollers
(without mixing valve system)
corpus powder-coated
gray RAL 7021.
Static payload max. 400 kg
Dim.: 482 w x 1,752 h x 382 d
Order No. 2331941 780,00



RGS 5000 „both-sides“

the same as above, but equipped on both sides (incl. 4 brushes, 2 scrubbing brushes, 2 dustpans, 2 sets shadowboards, 2 boards for cleaning products)

Order No. 2332183 749,00

Store your workshop trolleys clean and safe – The Apfel workshop trolley station

No matter how many workshop trolleys you want to store or which dimensions you need, we manufacture a station according to your specifications.

Lockable and due to its blinds with rubber lips nearly dust-free, this station is the perfect solution to store your workshop trolleys permanently safe and clean.



KRS Kanban shelf cabinets – Need-specific and flexible

Choose from diverse sizes, compositions and assemblies to set up your individual storage system fitting the material flow of your line production and profit from the highly efficient kanban principle.

Mount the storage shelves individually in a 50 mm pattern and tilt the shelves into diverse angles. Each KRS model comes with 4 easy-going guided rollers with brakes allowing trouble free transport and fixation at its place of usage.

Also available with straight shelves



Compatible shelf:
KRB 3900
23,00 / pcs.

KRS 3000
407 w x 1,952 h x 772 d
without shelves
Order No. 2332078 249,00



Compatible shelf:
KRB 4900
25,00 / pcs.

KRS 4000
512 w x 1,952 h x 772 d
without shelves
Order No. 2332081 259,00



Compatible shelf:
KRB 6900
26,00 / pcs.

KRS 6000
712 w x 1,952 h x 772 d
without shelves
Order No. 2332084 269,00



Compatible shelf:
KRB 8900
27,00 / pcs.

KRS 8000
917 w x 1,952 h x 772 d
without shelves
Order No. 2332087 279,00



KRS 3600
407 w x 1,952 h x 772 d
with 6 shelves KRB 3900
Order No. 2332080 388,00



KRS 4600
512 w x 1,952 h x 772 d
with 6 shelves KRB 4900
Order No. 2332083 409,00



KRS 6500
712 w x 1,952 h x 772 d
with 5 shelves KRB 6900
Order No. 2332086 399,00



KRS 8500
917 w x 1,952 h x 772 d
with 5 shelves KRB 8900
Order No. 2332089 415,00



R07

R06

R08-2
137257

R08-2
117814

R08-2
117814

R08-2
117814

R08-2
117814

R08-1
125580

125580
R08-1

**KLF / KES storage bins
and KEN euro code cases –
The containers which are perfectly
matched to the KRS series**

Arrange your storage space on the shelves with boxes and euro code cases according to your operational requirements.

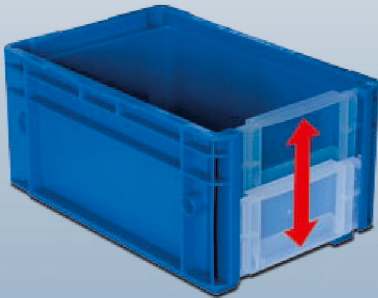

KES 3215
Dim.: 297 x 198 x 147,5
Order No. 2333390
Price on request



KES 4315
Dim.: 396 x 297 x 147,5
Order No. 2333391
Price on request

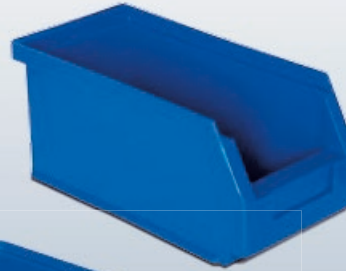

KLF 211 (No. 11)
Outer dim.: 160 x 100 x 75
Inner dim.: 133 x 88 x 67
Order No. 2331239 1,20

KLF 5 (No. 50)
Outer dim.: 290 x 140 x 130
Inner dim.: 249 x 121 x 128
Order No. 2330449 4,95

KLF 321 (No. 13)
Outer dim.: 350 x 220 x 145
Inner dim.: 292 x 182 x 133
Order No. 2331240 5,95



KEN 3212 (No. 30)
Outer dim.: 300 x 200 x 120
Inner dim.: 267 x 167 x 116
Order No. 2331808 4,80



KEN 4312 (No. 40)
Outer dim.: 400 x 300 x 120
Inner dim.: 367 x 267 x 116
Order No. 2331468 7,80



KEN 4318 (No. 41)
Outer dim.: 400 x 300 x 180
Inner dim.: 367 x 267 x 176
Order No. 2331467 8,90



KEN 4322 (No. 42)
Outer dim.: 400 x 300 x 220
Inner dim.: 367 x 267 x 216
Order No. 2331466 9,80



KEN 6412 (No. 60)
Outer dim.: 600 x 400 x 120
Inner dim.: 567 x 367 x 116
Order No. 2331470 10,80



KEN 6418 (No. 61)
Outer dim.: 600 x 400 x 180
Inner dim.: 567 x 367 x 176
Order No. 2331471 11,80



KEN 6422 (No. 62)
Outer dim.: 600 x 400 x 220
Inner dim.: 567 x 367 x 216
Order No. 2331472 12,60



KEN 6432 (No. 63)
Outer dim.: 600 x 400 x 320
Inner dim.: 567 x 367 x 316
Order No. 2331473 15,50



KEN 6442 (No. 64)
Outer dim.: 600 x 400 x 420
Inner dim.: 567 x 367 x 416
Order No. 2331474 19,90

**KRK 91/300**

Storage bins for series V
Outer dim.: 300 x 91 x 81
Order No. 4000600 4,40

KRK 91/400

Storage bins for series V
Outer dim.: 400 x 91 x 81
Order No. 4000601 4,90

TRW 91

Transparent divider
compatible to RK 91
Order No. 4000604 0,90

**KRK 183/300**

Storage bins for series V
Outer dim.: 300 x 183 x 81
Order No. 4000602 5,90

KRK 183/400

Storage bins for series V
Outer dim.: 400 x 183 x 81
Order No. 4000603 6,90

TRW 183

Transparent divider
compatible to RK 183
Order No. 4000605 1,10



WGH – the wall bracket for your welding workplace

The Apfel WGH wall bracket is the ideal basis to build a professional welding workplace where space is limited.

To built a perfect working environment, the wall holders can be individually equipped with extension arms of suitable length.

Talk to us, we create the welding workplace according to your specifications.

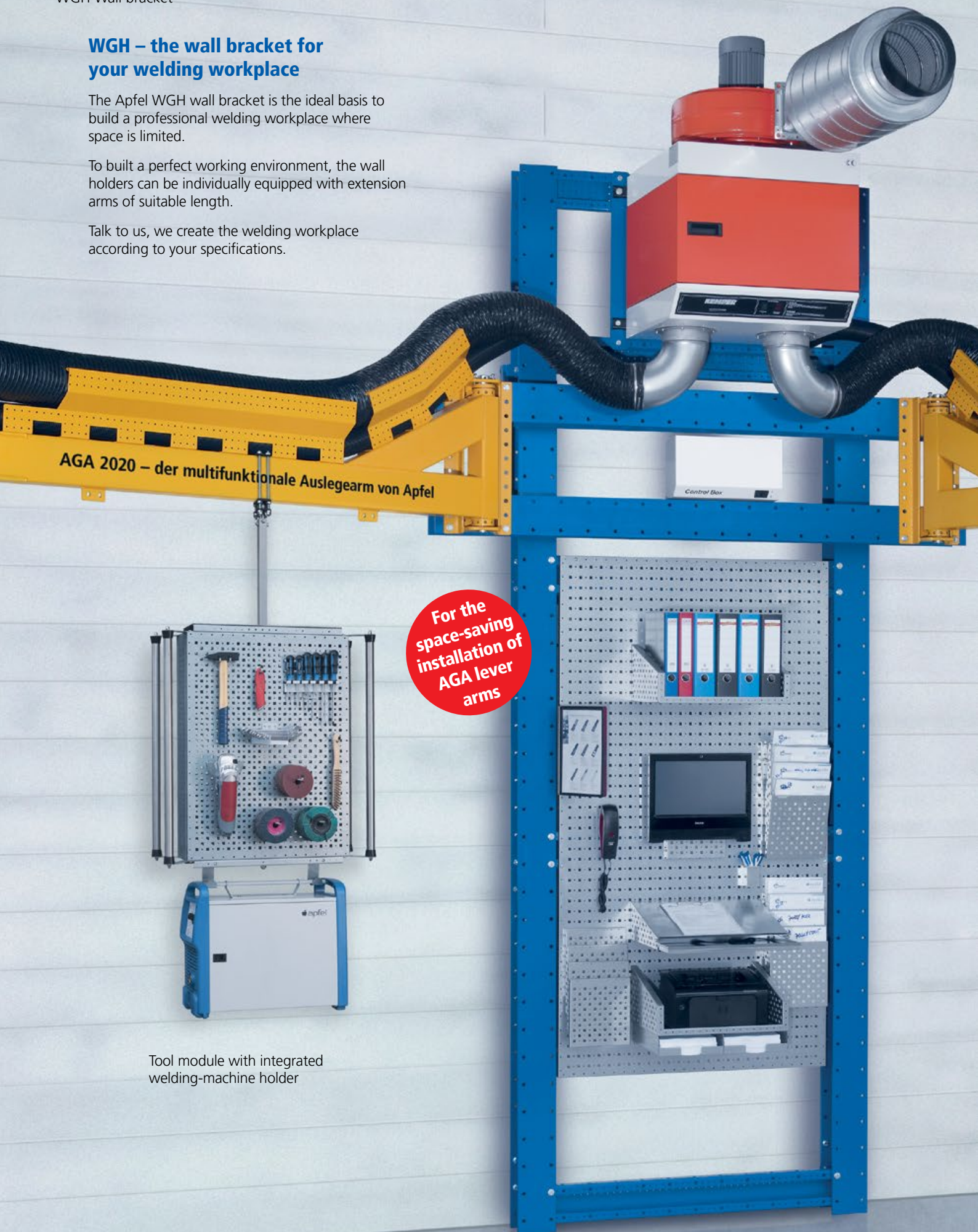

AGA 2020 – der multifunktionale Auslegearm von Apfel

For the space-saving installation of AGA lever arms

Tool module with integrated welding-machine holder

Accessories for the complete equipping of your work place

Complete your working environment with additional equipment modules to improve your efficiency with shorter processes and lower downtimes.

In addition to the spring-driven cable and hose reels, the tool module with integrated welding-machine holder and other technical accessories we offer a large selection of modules for a perfect organization of your work operations.



Spring-driven cable reel



Spring-driven hose reel



The AGA lever arm to mount on wall or girder

For the admission of all relevant supply lines and discharges. Incl. mounting plate and welding-kit, solid built and able to swivel in both directions.



AGA 1515

Lever arm with welding-kit
Length ca. 3 m (1,5 m + 1,5 m)
Order No. 2332483 1.850,00

AGA 3020

Lever arm with welding-kit
Length ca. 5 m (3 m + 2 m)
Order No. 2332479 2.150,00

AGA 2020

Lever arm with welding-kit
Length ca. 4 m (2 m + 2 m)
Order No. 2332477 1.980,00

AGA 4020

Lever arm with welding-kit
Length ca. 6 m (4 m + 2 m)
Order No. 2332478 2.280,00



Powder coating in all colour combinations (RAL)

In our modern plant we powder-coat even big parts with precise, consistent colouring and perfect structure.

Choose your desired colours from the whole RAL range and customize your equipment according to your company colours.

Realize your individual image and create an inviting and professional environment for the employees and visitors of your company.

For further information we place our services at your disposal.



Factory equipment in your special colours

For numerous renowned industrial companies from the widest possible variety of sectors, we produce storage systems and equipment according to their colour guidelines.

Create a pleasant and colour-accentuated working environment in your company.

Individual fitting to your machines and production facilities, we manufacture the equipment components in your desired colour combination at a low extra charge.

Realize a uniform overall appearance that reflects the professional standard of your company even in your workrooms.



RAL 3001
Signalrot
Signal red
Rouge de sécurité

RAL 3002
Karminrot
Carmine red
Rouge carmin

RAL 3003
Türmalme
Tumain red
Rouge tumain

RAL

RAL 3003



EMAG



Storage system for broaches with swivelling lifting device



Optimal utilisation of space and short access times through a drawer system for the storage of centering plates, integrated in the base frame of the machine

Customized systems with optimal product benefits

For many of our clients we manufacture transport systems, storage solutions and logistic systems according to their facility-specific requirements.

No matter if the reduction of access times, the optimization of space or the material structure due to specific requirements is in focus – with our individually manufactured equipment we satisfy the highest demands in sustainable and proper function, maximum safety and tailor-made engineering.

Because of our high vertical range of manufacture in metal processing and surface treatment, we produce nearly all projects of our clients in-house and achieve greater efficiency due to shortened workflows.

If large-dimension complete systems of carrier elements, the fitting components of a high-bay storage or the optimized layout for the partitioning of lift trays – we design, construct and realize compatible storage systems and commissioning solutions according to your operating processes, made to match the size of your business.



Shelf system with drawers for the storage of pharmaceutical products under deep-freeze conditions

Individual solutions for your special requirements

Take advantage of our great experience and practical approach to improve your workflow, to increase efficiency and to expand the storage capacities of your entire company.

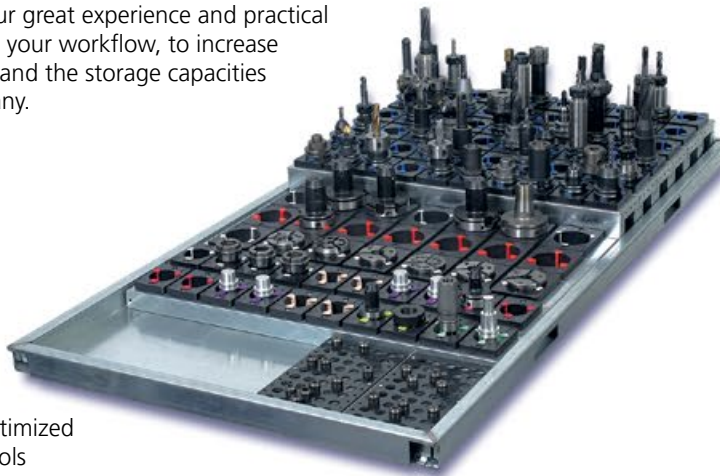

Lift tray for space-optimized storage of cutting tools



Transport cart for the storage of precision tools



Cabinet system with vertical drawers and sorting aid to store medium format metal sheets

The ideal dimension for your storage purposes and operations

Whether you want to store enormous quantities of filigree small parts or large and heavy tools – our special solutions store your working materials always perfect.

We develop your storage system according to your needs and we built your product with highest standards of safety, function and lifetime.

The workplace of the future

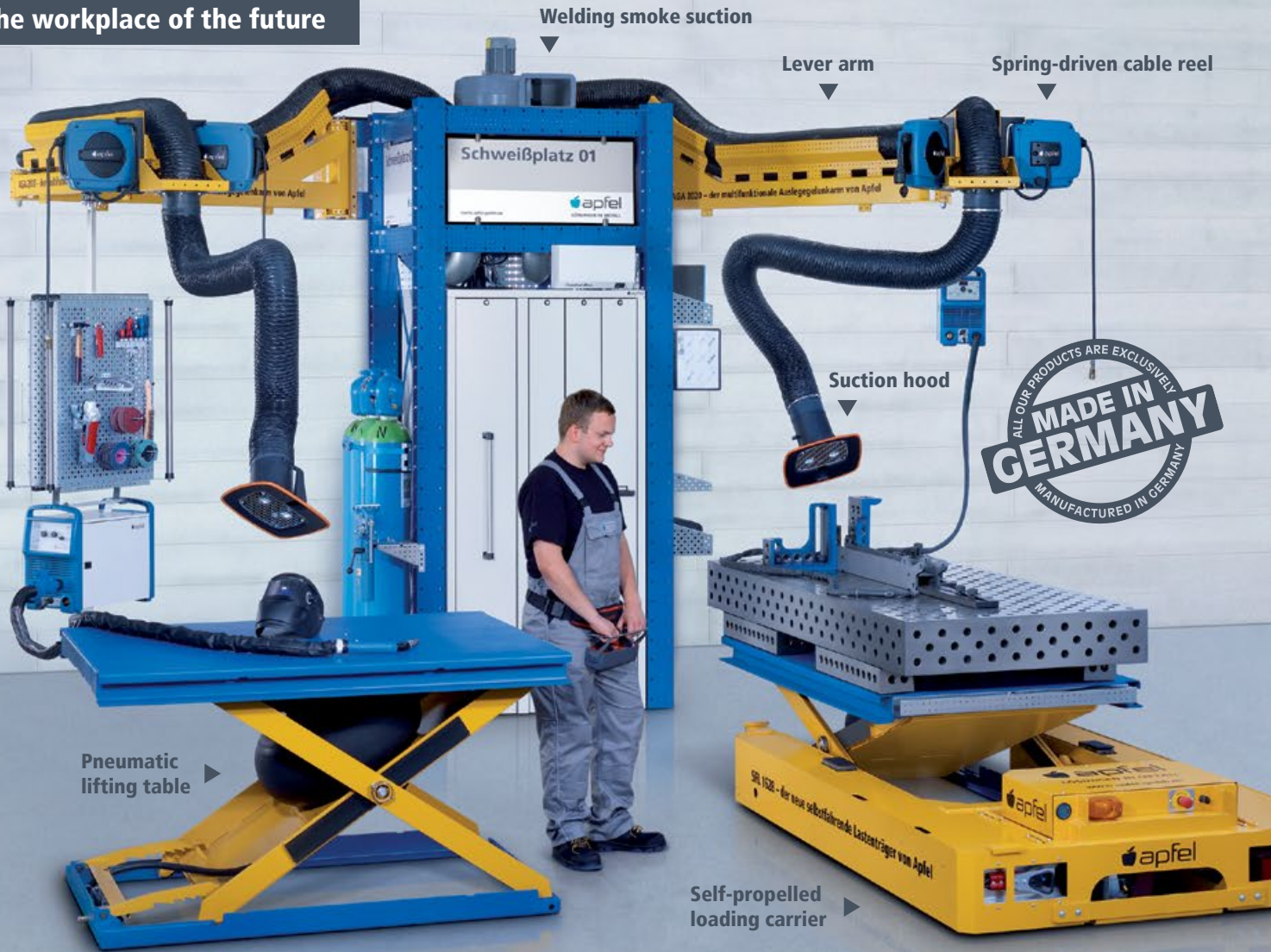

Get started into a new age of factory equipment with the multifunctional workstation concept by Apfel that ensures a production process of rapid, unhindered access and that prevents useless secondary processing times.

Absolutely free of any loose hoses or cables on the floor and completely fed by overhead lever arms the Apfel workstation concept makes your welding workplaces and assembly sites appreciably tidy, fast and save.

Supply electricity, compressed air, gas or any other operating material via overhead lever arms directly to your workstation and avoid safety risks like stumbling and tripping on cables or hoses left lying around.



Spring driven hose reel



Vice-set

Office station



Completely transportable by lift truck

 **apfel**
 Factory equipment that fits
www.apfel-gmbh.de

Apfel Metallverarbeitung GmbH
 Gerhart-Hauptmann-Str. 56
 D-69221 Dossenheim
 Phone +49 62 21 / 87 61- 0
 Fax +49 62 21 / 87 6125
info@apfel-gmbh.de

Subject to change without notice.
 Prices are quoted ex works.
 Dimensions in millimeters.
 Illustrated tools and accessories
 are not included.